



## FOR PERFECT RESULTS

Thank you for choosing this AEG product. We have created it to give you impeccable performance for many years, with innovative technologies that help make life simpler – features you might not find on ordinary appliances. Please spend a few minutes reading to get the very best from it.

## ACCESSORIES AND CONSUMABLES

In the AEG webshop, you'll find everything you need to keep all your AEG appliances looking spotless and working perfectly. Along with a wide range of accessories designed and built to the high quality standards you would expect, from specialist cookware to cutlery baskets, from bottle holders to delicate laundry bags...



Visit the webshop at:  
[www.aeg.com/shop](http://www.aeg.com/shop)

# CONTENTS

- 4 Safety information
- 5 Safety instructions
- 8 Product description
- 10 Operating instructions
- 14 Helpful hints and tips
- 15 Care and cleaning
- 16 What to do if...
- 17 Installation instructions
- 20 Environment concerns

The following symbols are used in this user manual:



Important information concerning your personal safety and information on how to avoid damaging the appliance.



General information and tips



Environmental information

Subject to change without notice.

## SAFETY INFORMATION

Before the installation and use of the appliance, carefully read the supplied instructions. The manufacturer is not responsible if an incorrect installation and use causes injuries and damages. Always keep the instructions with the appliance for future reference.

### Children and vulnerable people safety



#### **WARNING!**

Risk of suffocation, injury or permanent disability.

- This appliance can be used by children aged from 8 years and above and persons with reduced physical, sensory or mental capabilities or lack of experience and knowledge if they are supervised by an adult or a person who is responsible for their safety.
- Do not let children play with the appliance.
- Keep all packaging away from children.
- Keep children and pets away from the appliance when it operates or when it cools down. Accessible parts are hot.
- If the appliance has a child safety device, we recommend that you activate it.
- Cleaning and user maintenance shall not be made by children without supervision.

### General Safety

- The appliance and its accessible parts become hot during use. Do not touch the heating elements.
- Do not operate the appliance by means of an external timer or separate remote-control system.
- Unattended cooking on a hob with fat or oil can be dangerous and may result in fire.
- Never try to extinguish a fire with water, but switch off the appliance and then cover flame e.g. with a lid or a fire blanket.
- Do not store items on the cooking surfaces.
- Do not use a steam cleaner to clean the appliance.

- Metallic objects such as knives, forks, spoons and lids should not be placed on the hob surface since they can get hot.
- If the glass ceramic surface is cracked, switch off the appliance to avoid the possibility of electric shock.
- After use, switch off the hob element by its control and do not rely on the pan detector.



## SAFETY INSTRUCTIONS

### Installation



#### **WARNING!**

Only a qualified person must install this appliance.

- Remove all the packaging.
- Do not install or use a damaged appliance.
- Obey the installation instruction supplied with the appliance.
- Keep the minimum distance from the other appliances and units.
- Always be careful when you move the appliance because it is heavy. Always wear safety gloves.
- Seal the cut surfaces with a sealant to prevent moisture to cause swelling.
- Protect the bottom of the appliance from steam and moisture.
- Do not install the appliance adjacent to a door or under a window. This prevents hot cookware to fall from the appliance when the door or the window is opened.
- If the appliance is installed above drawers make sure that the space, between the bottom of the appliance and the upper drawer, is sufficient for air circulation.
- Make sure that the ventilation space of 2 mm, between the worktop and the front of the below unit, is free. The warranty does not cover damages caused by the lack of an adequate ventilation space.
- The bottom of the appliance can get hot. We recommend to install a non-combustible separation panel under the appliance to prevent access to the bottom.

### Electrical connection



#### **WARNING!**

Risk of fire and electrical shock.

- All electrical connections must be made by a qualified electrician.
- The appliance must be earthed.
- Before carrying out any operation make sure that the appliance is disconnected from the power supply.
- Use the correct electricity mains cable.
- Do not let the electricity mains cable tangle.

- Make sure the mains cable or plug (if applicable) does not touch the hot appliance or hot cookware, when you connect the appliance to the near sockets
- Make sure the appliance is installed correctly. Loose and incorrect electricity mains cable or plug (if applicable) can make the terminal become too hot.
- Make sure that a shock protection is installed.
- Use the strain relief clamp on cable.
- Make sure not to cause damage to the mains plug (if applicable) or to the mains cable. Contact the Service or an electrician to change a damaged mains cable.
- The electrical installation must have an isolation device which lets you disconnect the appliance from the mains at all poles. The isolation device must have a contact opening width of minimum 3 mm.
- Use only correct isolation devices: line protecting cut-outs, fuses (screw type fuses removed from the holder), earth leakage trips and contactors.

## Use



### **WARNING!**

Risk of injury, burns or electric shock.

- Remove all the packaging, labelling and protective film (if applicable) before first use.
- Use this appliance in a household environment.
- Do not change the specification of this appliance.
- Do not let the appliance stay unattended during operation.
- Do not operate the appliance with wet hands or when it has contact with water.
- Do not put cutlery or saucepan lids on the cooking zones. They can become hot.
- Set the cooking zone to "off" after each use. Do not rely on the pan detector.
- Do not use the appliance as a work surface or as a storage surface.
- If the surface of the appliance is cracked, disconnect immediately the appliance from the power supply. This to prevent an electrical shock.
- Users with a pacemaker must keep a distance of minimum 30 cm from the induction cooking zones when the appliance is in operation.
- When you place food into hot oil, it may splash.



### **WARNING!**

Risk of fire or explosion.

- Fats and oil when heated can release flammable vapours. Keep flames or heated objects away from fats and oils when you cook with them.
- The vapours that very hot oil releases can cause spontaneous combustion.
- Used oil, that can contain food remnants, can cause fire at a lower temperature than oil used for the first time.
- Do not put flammable products or items that are wet with flammable products in, near or on the appliance.



### **WARNING!**

Risk of damage to the appliance.

- Do not keep hot cookware on the control panel.
- Do not let cookware to boil dry.
- Be careful not let objects or cookware fall on the appliance. The surface can be damaged.
- Do not activate the cooking zones with empty cookware or without cookware.
- Do not put aluminium foil on the appliance.
- Cookware made of cast iron, aluminium or with a damaged bottom can cause scratches on the glass or glass ceramic. Always lift these objects up when you have to move them on the cooking surface.

## Care and Cleaning



### **WARNING!**

Risk of damage to the appliance.

- Clean regularly the appliance to prevent the deterioration of the surface material.
- Do not use water spray and steam to clean the appliance.
- Clean the appliance with a moist soft cloth. Only use neutral detergents. Do not use abrasive products, abrasive cleaning pads, solvents or metal objects.

## Disposal



### **WARNING!**

Risk of injury or suffocation.

- Contact your municipal authority for information on how to discard the appliance correctly.
- Disconnect the appliance from the mains supply.
- Cut off the mains cable and discard it.

## Service

- Contact the Service to repair the appliance. We recommend only the use of original spare parts.

## PRODUCT DESCRIPTION

### General overview

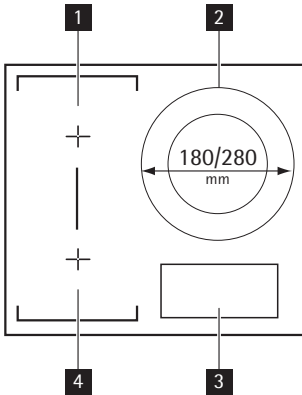

- 1** Induction cooking zone 2300 W, with Power function 3200 W
- 2** Double ring induction cooking zone 1800/2800 W, with Power function 3500/3700 W (minimum cookware diameter = 145 mm).
- 3** Control panel
- 4** Induction cooking zone 2300 W, with Power function 3200 W

### Control panel layout

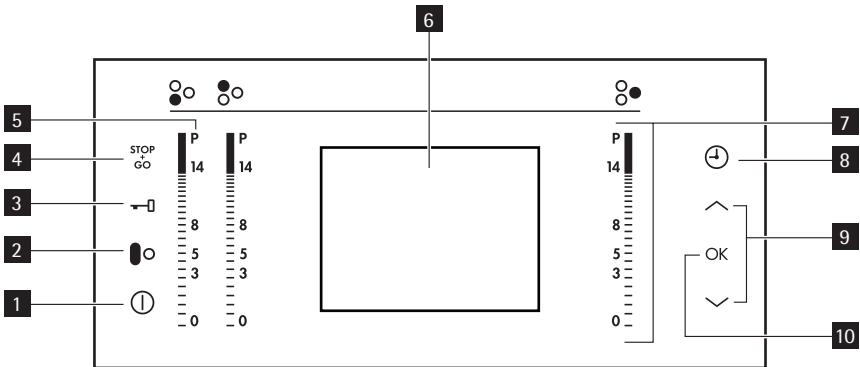

Use the sensor fields to operate the appliance. Indicators, displays and sounds tell which functions operate.

	sensor field	function
<b>1</b>	①	It activates and deactivates the appliance.
<b>2</b>	●○	It activates and deactivates the Bridge function.
<b>3</b>	—□	It locks/unlocks the control panel.
<b>4</b>	STOP GO	It activates and deactivates the STOP+GO function.
<b>5</b>	P	It activates the Power Boost function.
<b>6</b>	the display	It shows the functions that operate.







	sensor field	function
<b>7</b>	the control bar	To set the heat setting.
<b>8</b>		It sets the timer ( Automatic Counter , Power-off timer , Minute Minder ).
<b>9</b>	$\wedge / \vee$	It set the settings.
<b>10</b>	OK	It confirms the setting.

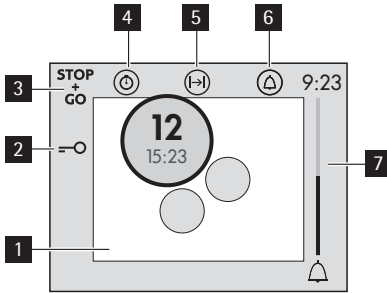

## Display

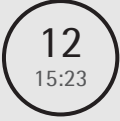
Messages in the display and sounds tell which functions operate.



- 1** The cooking zones
- 2** The Key lock function operates.
- 3** The  $\text{STOP} + \text{GO}$  function operates.
- 4** Automatic Counter
- 5** Power-off timer
- 6** Minute Minder
- 7** Minute Minder indicator

The cooking zone in the display	Description
	The cooking zone operates. Above: heat setting, below: the timer.
	Keep Warm / STOP+GO function operates.
	Power Boost is activated.
	Power Boost operates.
	Zone in adjustment.

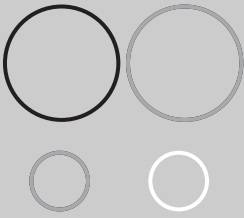
The cooking zone in the display	Description
	There is no cookware on the cooking zone.
	The Automatic Heat Up function operates.
	<p><b>OptiHeat Control.</b> The cooking zone is off. The Dimension and colours show the <b>residual heat</b>:</p> <ul style="list-style-type: none"> <li>• Big red - still cooking</li> <li>• Big bright red - keep warm</li> <li>• Small bright red - still hot</li> <li>• Small white - the cooking zone is cold</li> </ul>

## Residual heat



### **WARNING!**

After, a cooking session the cooking zone stay hot. The risk of burns!

The induction cooking zones make the heat necessary for cooking directly in the bottom of the cookware. The glass ceramic is hot from the heat of the cookware.

## OPERATING INSTRUCTIONS

### Activation and deactivation

Touch  for 1 second to activate or deactivate the appliance.

### Automatic Switch Off

The function deactivates the appliance automatically if:

- All cooking zones are deactivated.
- You do not set the heat setting after you activate the appliance.
- You spill something or put something on the control panel for more than 10 seconds, (a pan, a cloth, etc.). The sound operates some time and the appliance deactivates. Remove the object or clean the control panel.
- The appliance gets too hot (e.g. when, a saucepan boils dry). Before you use the hob again, the cooking zone must be cool.
- You use incorrect cookware. The symbol ? comes on and the cooking zone deactivates automatically after 2 minutes.

- You do not deactivate a cooking zone or change the heat setting. After some time, the appliance deactivates. See the table.

The times of Automatic Switch Off

The heat setting	1-3	4-7	8-9	10-14
The cooking zone deactivates after	6 hours	5 hours	4 hours	1.5 hours

### Language selection

To change the language, start the appliance with  and then touch **OK**. Set the language menu with arrows. Touch **OK** to confirm. The display shows the list of languages. Touch  $\wedge$  or  $\vee$  to set the language. Touch **OK** to confirm.

### The heat setting

Touch the control bar at the heat setting. Change up or down, if it is necessary. Do not release before you have a correct heat setting. The display shows the heat setting and the counter starts.

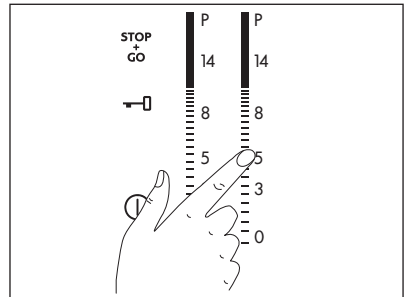

### Bridge function

The Bridge function connects two left side cooking zones and they operate as one.

First set the heat setting for one of the left cooking zones.

To start the Bridge function touch . To set or change the heat setting touch one of the left control sensors.

To stop the Bridge function touch . The cooking zones operate independently.

### The Automatic Heat Up

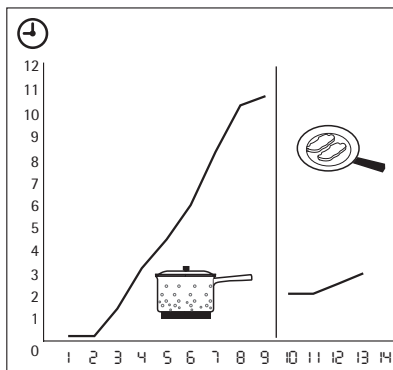

You can get a necessary heat setting in a shorter time if you activate the Automatic Heat Up function. This function sets the highest heat setting for some time (see the illustration), and then decreases to the necessary heat setting.

To start the Automatic Heat Up function for a cooking zone:

1. Touch **P**.
2. Immediately touch the necessary heat setting. (A comes on the display)

To deactivate the function change the heat setting.

## Power Boost

Power Boost makes more power available to the induction cooking zones. Power Boost is activated for 10 minutes at most. After, that the induction cooking zone automatically sets back to highest heat setting.

To activate the function, touch **P** . **P** in the ring comes on. As the zone gets more hot, the colour of the ring changes.

To deactivate, touch a heat setting 1-14.

## Power Boost of the double ring cooking zone

Power Boost of the inner ring starts when the appliance senses the cookware with a smaller diameter than the inner ring. Power Boost of the outer ring starts when the appliance senses the cookware with a larger diameter than the inner ring.

## Power management

The power management divides the power between two cooking zones in a pair (see the illustration). The power function increases the power to the maximum level for one cooking zone in the pair. Automatically decreases the power in the second cooking zone to a lower level. The display for the reduced zone change between two levels.

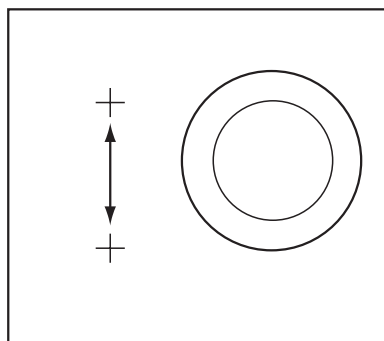

## Timer

There are 3 timer functions: Automatic Counter , Power-off timer and Minute Minder . To set the timer function touch  $\ominus$  again and again until the indicator of a necessary function comes on.

### $\odot$ Automatic Counter

Use this function to monitor how long the cooking zone operates. It starts automatically and comes on below heat setting in the cooking zone on the display.

- To reset the Automatic Counter , touch  $\ominus$  to get the Automatic Counter  $\odot$  . Then set the cooking zone from the list with arrows and touch OK to confirm .

### Power-off timer

Use the Power-off timer to set how long the cooking zone operates for only this one time. Touch  two times to get the Power-off timer. Then set the cooking zone from the list with arrows and touch **OK** to confirm. Set the time with arrows and touch **OK** to confirm. When the time comes to an end, the zone deactivates.



- To stop the sound: touch 

### Minute Minder

Touch  three times to get the Minute Minder. Set the time with arrows. The Minute Minder indicator comes on. When the time comes to an end, the sound operates.



- To stop the sound: touch 

## STOP+GO

The  function sets all cooking zones that operate to the lowest heat setting ().

When  operates, you cannot change the heat setting.



The  function does not stop the timer function.

- To activate this function touch . The symbol  comes on.
- To deactivate this function touch . The heat setting that you set before comes on.

## Lock

When the cooking zones operate, you can lock the control panel, but not . It prevents an accidental change of the heat setting.

First set the heat setting.

To activate this function touch . The symbol  comes on.

The Timer stays on.



To deactivate this function touch . The heat setting that you set before comes on.

When you deactivate the appliance, you also deactivate this function.



## The Child Safety Device

This function prevents an accidental operation of the appliance.





To activate The Child Safety Device:

- Touch  for 4 seconds when all zones are off or when the appliance is shutting down. The display shows the message, that The Child Safety Device operates.
- Deactivate the appliance with .

To deactivate The Child Safety Device

- Activate the appliance with .
- Touch  and then **OK**.

To override The Child Safety Device for only one cooking time

- Activate the appliance with . Touch  and .
- Set the heat setting in 10 seconds. You can operate the appliance. When you deactivate the appliance with , The Child Safety Device operates again.

## Deactivation and activation of the sounds

Activate the appliance. Touch **OK** and then set the sound menu with arrows. Touch **OK** to confirm. Set the option with the arrows. Touch **OK** to confirm.

When this function operates, you can hear the sounds only when:

- you touch ①
- the Minute Minder comes down
- the Power-off timer comes off
- you put something on the control panel.

## HELPFUL HINTS AND TIPS



Use the induction cooking zones with correct cookware.



Put the cookware on the cross which is on the surface that you cook. Cover the cross fully. The magnetic part of the bottom of the cookware must be 125mm minimum. Induction cooking zones adapt to the dimension of the bottom of the cookware automatically. You can cook with the large cookware on two cooking zones at the same time.

### Cookware for induction cooking zones



For induction cooking zones a strong electro-magnetic field creates the heat in the cookware very quickly.

#### Cookware material

- **correct:** cast iron, steel, enamelled steel, stainless steel, the bottom made of multi-layer (with correct mark from a manufacturer).
- **not correct:** aluminium, copper, brass, glass, ceramic, porcelain.

Cookware is correct for an induction hob if ...

- ... some water boils very quickly on a zone set to the highest heat setting.
- ... a magnet pulls on to the bottom of the cookware.



The bottom of the cookware must be as thick and flat as possible.

Cookware dimensions: induction cooking zones adapt to the dimension of the bottom of the cookware automatically to some limit.

### The noises during operation

If you can hear

- crack noise: cookware is made of different materials (Sandwich construction).
- whistle sound: you use one or more cooking zones with high power levels and the cookware is made of different materials (Sandwich construction).
- humming: you use high power levels.
- clicking: electric switching occurs.
- hissing, buzzing: the fan operates.

The noises are normal and do not refer to appliance malfunction.

## Energy saving



- If it is possible, always put the lids on the cookware.
- Put cookware on a cooking zone before you start it.

## Öko Timer (Eco Timer)



To save energy, the heater of the cooking zone deactivates before the count down timer sounds. The difference in the operation time depends on the heat setting level and the length of the cooking operation.

## The examples of cooking applications

The data in the table is for guidance only.

Heat setting	Use to:	Time	Hints
1	Keep cooked foods warm	as necessary	Put a lid on a cookware.
1-3	Hollandaise sauce, melt: butter, chocolate, gelatine	5-25 min	Mix from time to time.
1-3	Solidify: fluffy omelettes, baked eggs	10-40 min	Cook with a lid on.
3-5	Simmer rice and milkbased dishes, heating up ready-cooked meals	25-50 min	Add the minimum two times as much liquid as rice, mix milk dishes at some point of the procedure through.
5-7	Steam vegetables, fish, meat	20-45 min	Add some tablespoons of liquid.
7-9	Steam potatoes	20-60 min	Use max. ¼ l water for 750 g of potatoes.
7-9	Cook larger quantities of food, stews and soups	60-150 min	Up to 3 l liquid plus ingredients.
9-12	Gentle fry: escalope, veal cordon bleu, cutlets, rissoles, sausages, liver, roux, eggs, pancakes, doughnuts	as necessary	Turn halfway through.
12-13	Heavy fry, hash browns, loin steaks, steaks	5-15 min	Turn halfway through.
14	Boil large quantities of water, cook pasta, sear meat (goulash, pot roast), deep fry chips.		

The Power function is best to heat up large quantities of water.

## CARE AND CLEANING

Clean the appliance after each use.  
Always use cookware with clean bottom.

**WARNING!**

The sharp objects and abrasive cleaning agents can cause damage to the appliance. For your safety, do not clean the appliance with steam cleaners or high-pressure cleaners.



Scratches or dark stains on the glass-ceramic cause no effect on how the appliance operates.

To remove the dirt:

1. – **Remove immediately:** melted plastic, plastic foil, and food with sugar. If not, the dirt can cause damage to the appliance. Use a special scraper for the glass. Put the scraper on the glass surface at an acute angle and move the blade on the surface.
  - **Remove after the appliance is sufficiently cool:** limescale rings, water rings, fat stains, shiny metallic discolorations. Use a special cleaning agent for glass ceramic or stainless steel.
2. Clean the appliance with a moist cloth and some detergent.
3. At the end **rub the appliance dry with a clean cloth.**

**WHAT TO DO IF...**

Problem	Possible cause and remedy
You cannot activate the appliance or operate it.	<ul style="list-style-type: none"> <li>• Activate the appliance again and set the heat setting in 10 seconds.</li> <li>• You touched 2 or more sensor fields at the same time. Only touch one sensor field.</li> <li>• The Child Safety Device or the Lock or <math>\frac{STOP}{GO}</math> operates. See the chapter Operating instructions.</li> <li>• There is water or fat stains on the control panel. Clean the control panel.</li> </ul>
A Sound operates and the appliance deactivates. A sound operates when the appliance is deactivated.	You put something on one or more sensor fields. Remove the object from the sensor fields.
The residual heat indicator does not change the colour.	The cooking zone is not hot because it operated only for a short time. If the cooking zone should be hot, speak to the service centre.
The Automatic Heat Up function does not operate.	<ul style="list-style-type: none"> <li>• There is still residual heat on the cooking zone. Let the cooking zone become sufficiently cool.</li> <li>• The highest heat setting is set. The highest heat setting has the same power as the Automatic Heat Up function.</li> </ul>
The heat setting changes between two levels.	The Power management is activated. See the section Power management.
The sensor fields become hot.	The cookware is too large or you put it too near to the controls. Put large cookware on the rear cooking zones if it is necessary.



Problem	Possible cause and remedy
There is no signal when you touch the panel sensor fields.	The signals are deactivated. Activate the signals (see OffSound Control).
The backlight is on but the contrast of the display is bad.	The hot cookware is on the display. Remove the object and let the appliance become sufficiently cool. If the contrast do not come back, speak to service centre.
ll and text comes on	The Automatic Switch Off operates. Deactivate the appliance and activate it again.
? comes on	<ul style="list-style-type: none"> <li>• No cookware on the cooking zone. Put cookware on the cooking zone.</li> <li>• Not correct cookware. Use the correct cookware.</li> <li>• The diameter of the bottom of the cookware is too small for the cooking zone. Use cookware with correct dimensions.</li> <li>• The cookware do not cover the cross. Cover the cross fully.</li> </ul>
E and number comes on.	There is an error in the appliance. Disconnect the appliance from the electrical supply for some time. Disconnect the fuse from the electrical system of the house. Connect again. If [E] comes on again, speak to the service centre.
E4 comes on	There is an error in the appliance, because a cookware boils dry. The protection against become too hot for the cooking zone operates. The Automatic Switch Off operates. Deactivate the appliance. Remove the hot cookware. After, approximately 30 seconds activate the cooking zone again. The error message should go out of the display, residual heat indicator can stay. Let the cookware become sufficiently cool and check it with the section Cookware for the induction cooking zone.

If you tried the above solutions and cannot repair the problem, speak to your dealer or the customer service. Give the data from the rating plate, three digit letter code for the glass ceramic (it is in the corner of the glass surface) and an error message that comes on. Make sure, you operated the appliance correctly. If not the servicing by a customer service technician or dealer will not be free of charge, also during the warranty period. The instructions about the customer service and conditions of guarantee are in the guarantee booklet.

## INSTALLATION INSTRUCTIONS

 Before the installation, note down the serial number (Ser. Nr.) from the rating plate. The rating plate of the appliance is on its lower casing.

Modell HK683320XG	Prod.Nr. 949 595 029 00
Typ 58 GAD C4 AU	220-240 V 50-60-Hz Induction 7,4kW
Made in Germany	Ser.Nr. .... 7,4 kW
AEG	CE 

### The Safety Instructions

 **WARNING!**  
You must read these!

- Make sure that the appliance is not damaged because of transportation. Do not connect a damaged appliance. If it is necessary, speak to the supplier.
- Only an authorized servicing technician can install, connect or repair this appliance. Use only original spare parts.
- Only use the built-in appliances after you assemble the appliance into correct built-in units and work surfaces that align to the standards.
- Do not change the specifications or change this product. Risk of injury and damage to the appliance.
- Fully obey the laws, ordinances, directives and standards in force in the country where you use the appliance (safety regulations, recycling regulations, electrical safety rules etc.)!
- Keep the minimum distances to other appliances and units!
- Install shock protection, for example install the drawers only with a protective floor directly below the appliance!
- Keep safe the cut surfaces of the worktop from moisture with a correct sealant!
- Seal the appliance to the work top with no space between with a correct sealant!
- Keep safe the bottom of the appliance from steam and moisture, e.g. from a dishwasher or oven!
- Do not install the appliance adjacent to doors and below windows! If not, when you open the doors or windows they can push off hot cookware from the appliance.

**WARNING!**

Risk of injury from electrical current. Carefully obey the instructions for electrical connections.

- The electrical mains terminal is live.
- Make electrical mains terminal free of voltage.
- Install correctly to give shock protection.
- Loose and incorrect plug and socket connections can make the terminal become too hot.
- A qualified electrician must install the connections in the clamps correctly.
- Use a strain relief clamp on cable.
- Use the correct mains cable of type H05BB-F Tmax 90°C (or higher) for a single phase or two phase connection.
- Replace the damaged mains cable with a special cable (type H05BB-F Tmax 90°C; or higher). Speak to your local Service Centre.

The appliance must have the electrical installation which lets you disconnect the appliance from the mains at all poles with a contact opening width of minimum 3 mm.

You must have correct devices to isolate: line protecting cut-outs, fuses (screw type fuses removed from the holder), earth leakage trips and contactors.

## Assembly

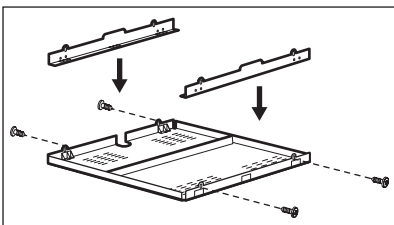
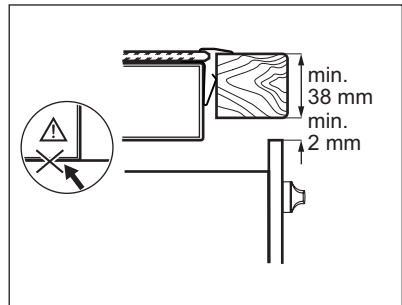
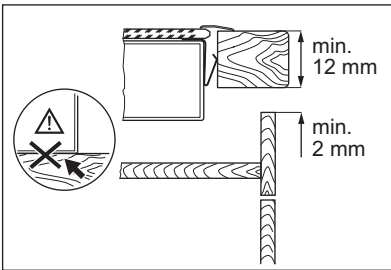
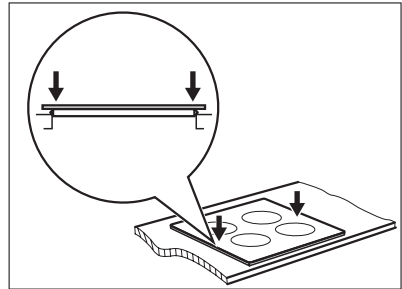
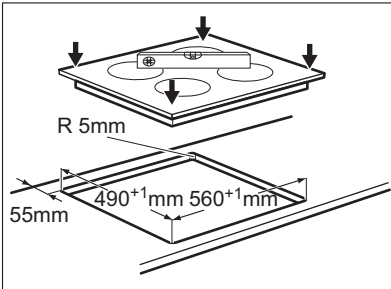
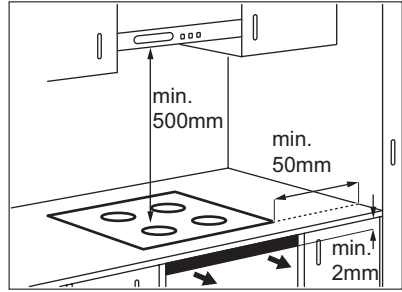
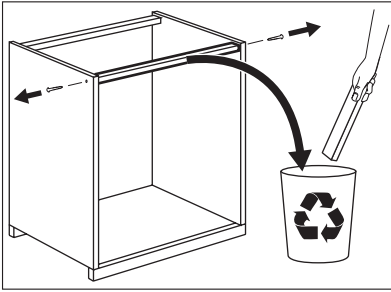

If you use a protection box (an additional accessory<sup>1)</sup>), the front airflow space of 2 mm and protective floor directly below the appliance are not necessary.

You can not use the protection box if you install the appliance above an oven.

1) The protection box accessory may not be available in some countries. Please contact your local supplier.

## ENVIRONMENT CONCERNS

Recycle the materials with the symbol ♻️. Put the packaging in applicable containers to recycle it.

Help protect the environment and human health and to recycle waste of electrical and electronic appliances. Do not dispose appliances marked with the symbol ⚡ with the household waste. Return the product to your local recycling facility or contact your municipal office.

### Packaging material



The packaging materials are friendly to the environment and can be recycled. The plastic components are identified by marking: >PE<,>PS<, etc. Discard the packaging materials as household waste at the waste disposal facilities in your municipality.







[www.aeg.com/shop](http://www.aeg.com/shop)

892933789-E-152013

