

USER MANUAL

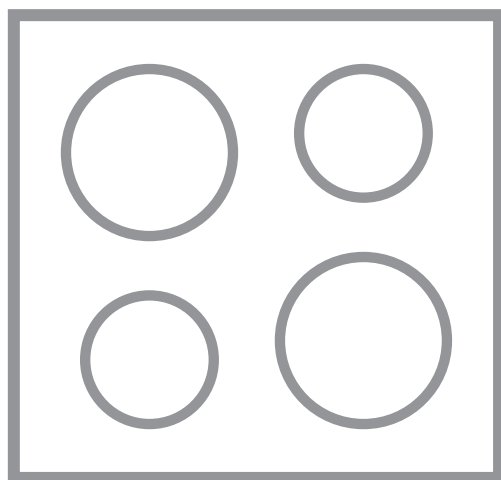

Important Information that may impact your Manufacturer's Warranty

Adherence to the directions for use in this manual is extremely important for health and safety. Failure to strictly adhere to the requirements in this manual may result in personal injury, property damage and affect your ability to make a claim under the AEG manufacturer's warranty provided with your product. Products must be used, installed and operated in accordance with this manual. You may not be able to claim on the AEG manufacturer's warranty in the event that your product fault is due to failure to adhere to this manual.

FOR PERFECT RESULTS

Thank you for choosing this AEG product. We have created it to give you impeccable performance for many years, with innovative technologies that help make life simpler features you might not find on ordinary appliances. Please spend a few minutes reading to get the very best from it.

Visit our website for:



Get usage advice, brochures, trouble shooter, service information:
www.aeg.com



Register your product for better service:
www.registeraeg.com

CUSTOMER CARE AND SERVICE

Always use original spare parts.

When contacting our Authorised Service Centre, ensure that you have the following data available: Model, PNC, Serial Number.

The information can be found on the rating plate.

 Warning / Caution-Safety information

 General information and tips

 Environmental information

Subject to change without notice.

CONTENTS

1. SAFETY INFORMATION.....	3
2. CONDITIONS OF USE.....	4
3. SAFETY INSTRUCTIONS.....	5
4. INSTALLATION.....	7
5. PRODUCT DESCRIPTION.....	8
6. DAILY USE.....	10
7. HINTS AND TIPS.....	13
8. CARE AND CLEANING.....	15
9. TROUBLESHOOTING.....	15
10. TECHNICAL DATA.....	17
11. ENERGY EFFICIENCY.....	17
12. WARRANTY	18

1. ⚠️ SAFETY INFORMATION

Before the installation and use of the appliance, carefully read the supplied instructions. The manufacturer is not responsible for any injuries or damage that are the result of incorrect installation or usage. Always keep the instructions in a safe and accessible location for future reference.

1.1 Children and vulnerable people safety

- This appliance can be used by children aged from 8 years and above and persons with reduced physical, sensory or mental capabilities or lack of experience and knowledge if they have been given supervision or instruction concerning the use of the appliance in a safe way and understand the hazards involved.
- Children between 3 and 8 years of age and persons with very extensive and complex disabilities shall be kept away from the appliance unless continuously supervised.
- Children of less than 3 years of age should be kept away from the appliance unless continuously supervised.
- Do not let children play with the appliance.
- Keep all packaging away from children and dispose of it appropriately.
- **WARNING:** Keep children and pets away from the appliance when it operates or when it cools down. Accessible parts become hot during use.
- If the appliance has a child safety device, it should be activated.
- Children shall not carry out cleaning and user maintenance of the appliance without supervision.

1.2 General Safety

- **WARNING:** The appliance and its accessible parts become hot during use. Care should be taken to avoid touching heating elements.
- **WARNING:** Unattended cooking on a hob with fat or oil can be dangerous and may result in fire.

- NEVER try to extinguish a fire with water, but switch off the appliance and then cover flame e.g. with a lid or a fire blanket.
- CAUTION: The appliance must not be supplied through an external switching device, such as a timer, or connected to a circuit that is regularly switched on and off by a utility.
- CAUTION: The cooking process has to be supervised. A short term cooking process has to be supervised continuously.
- WARNING: Danger of fire: Do not store items on the cooking surfaces.
- Metallic objects such as knives, forks, spoons and lids should not be placed on the hob surface since they can get hot.
- Do not use the appliance before installing it in the built-in structure.
- Do not use a steam cleaner to clean the appliance.
- If the glass ceramic surface / glass surface is cracked, switch off the appliance and unplug it from the mains. In case the appliance is connected to the mains directly using junction box, remove the fuse to disconnect the appliance from power supply. In either case contact the Authorised Service Centre.
- If the supply cord is damaged, it must be replaced by the manufacturer, an authorized Service or similarly qualified persons in order to avoid a hazard.
- WARNING: Use only hob guards designed by the manufacturer of the cooking appliance or indicated by the manufacturer of the appliance in the instructions for use as suitable or hob guards incorporated in the appliance. The use of inappropriate guards can cause accidents.

2. CONDITIONS OF USE

This appliance is intended to be used in household and similar applications such as:

- Farm houses

- By clients in serviced apartments, holiday apartments and other residential type environments.

3. SAFETY INSTRUCTIONS

3.1 Installation

**WARNING!**

Only a qualified person must install this appliance.

**WARNING!**

Risk of injury or damage to the appliance.

- Remove all the packaging.
- Do not install or use a damaged appliance.
- Follow the installation instructions supplied with the appliance.
- Keep the minimum distance from other appliances and units.
- Always take care when moving the appliance as it is heavy. Always use safety gloves and enclosed footwear.
- Seal the cut surfaces with a sealant to prevent moisture from causing swelling.
- Protect the bottom of the appliance from steam and moisture.
- Do not install the appliance next to a door or under a window. This prevents hot cookware from falling from the appliance when the door or the window is opened.
- If the appliance is installed above drawers make sure that the space, between the bottom of the appliance and the upper drawer is sufficient for air circulation.
- The bottom of the appliance can get hot. Make sure to install a separation panel made from plywood, kitchen carcass material or other non-flammable materials under the appliance to prevent access to the bottom.
- The separation panel has to cover the area under the hob completely.

3.2 Electrical Connection

**WARNING!**

Risk of fire and electric shock.

- All electrical connections should be made by a qualified electrician.
- The appliance must be earthed.
- Before carrying out any operation make sure that the appliance is disconnected from the power supply.

- Make sure that the parameters on the rating plate are compatible with the electrical ratings of the mains power supply.
- Make sure the appliance is installed correctly. Loose and incorrect electricity mains cable or plug (if applicable) can make the terminal become too hot.
- Use the correct electricity mains cable.
- Do not let the electricity mains cable tangle.
- Make sure that a shock protection is installed.
- Use the strain relief clamp on the cable.
- Make sure the mains cable or plug (if applicable) does not touch the hot appliance or hot cookware, when you connect the appliance to the near sockets.
- Do not use multi-plug adapters and extension cables.
- Make sure not to cause damage to the mains plug (if applicable) or to the mains cable. Contact our Authorised Service Centre or an electrician to change a damaged mains cable.
- The shock protection of live and insulated parts must be fastened in such a way that it cannot be removed without tools.
- Connect the mains plug to the mains socket only at the end of the installation. Make sure that there is access to the mains plug after the installation.
- If the mains socket is loose, do not connect the mains plug.
- Do not pull the mains cable to disconnect the appliance. Always pull the mains plug.
- Use only correct isolation devices: line protecting cut-outs, fuses (screw type fuses removed from the holder), earth leakage trips and contactors.
- The electrical installation must have an isolation device which lets you disconnect the appliance from the mains at all poles. The isolation device must have a contact opening width of minimum 3 mm.

3.3 Use

**WARNING!**

Risk of injury, burns and electric shock.

- Remove all the packaging, labelling and protective film (if applicable) before first use.
- This appliance is for household use only.
- Do not change the specification of this appliance.
- Make sure that the ventilation openings are not blocked.
- Do not let the appliance stay unattended during operation.
- Set the cooking zone to “off” after each use.
- Do not put cutlery or saucepan lids on the cooking zones. They can become hot.
- Do not operate the appliance with wet hands or when it has contact with water.
- Do not use the appliance as a work surface or as a storage surface.
- If the surface of the appliance is cracked, disconnect immediately the appliance from the power supply. This to prevent an electrical shock.
- When you place food into hot oil, it may splash.



WARNING!

Risk of fire and explosion

- Fats and oil when heated can release flammable vapours. Keep flames or heated objects away from fats and oils when you cook with them.
- The vapours that very hot oil releases can cause spontaneous combustion.
- Used oil, that can contain food remnants, can cause fire at a lower temperature than oil used for the first time.
- Do not put flammable products or items that are wet with flammable products in, near or on the appliance.



WARNING!

Risk of damage to the appliance.

- Do not keep hot cookware on the control panel.
- Do not put a hot pan cover on the glass surface of the hob.
- Do not let cookware boil dry.
- Be careful not to let objects or cookware fall on the appliance. The surface can be damaged.
- Do not activate the cooking zones with empty cookware or without cookware.
- Do not put aluminium foil on the appliance.

- Cookware made of cast iron, aluminium or with a damaged bottom can cause scratches on the glass / glass ceramic. Always lift these objects up when you have to move them on the cooking surface.
- This appliance is for cooking purposes only. It must not be used for other purposes, for example room heating.

3.4 Care and cleaning

- Clean the appliance regularly to prevent the deterioration of the surface material.
- Switch off the appliance and let it cool down before cleaning.
- Do not use water spray and steam to clean the appliance.
- Clean the appliance with a moist soft cloth. Use only neutral detergents. Do not use abrasive products, abrasive cleaning pads, solvents or metal objects.

3.5 Service

- To repair the appliance contact the Authorised Service Centre. Use original spare parts only.
- Concerning the lamp(s) inside this product and spare part lamps sold separately: These lamps are intended to withstand extreme physical conditions in household appliances, such as temperature, vibration, humidity, or are intended to signal information about the operational status of the appliance. They are not intended to be used in other applications and are not suitable for household room illumination.

3.6 Disposal



WARNING!

Risk of injury or suffocation.

- Contact your municipal authority for information on how to discard the appliance correctly.
- Disconnect the appliance from the mains supply.
- Cut off the mains electrical cable close to the appliance and dispose of it.

4. INSTALLATION



WARNING!

Refer to Safety chapters.

4.1 Before the installation

Before you install the hob, write down the information below from the rating plate. The rating plate is on the bottom of the hob.

Serial number

4.2 Built-in hobs

Only use the built-in hobs after you assemble the hob into correct built-in units and work surfaces that align to the standards.

4.3 Connection cable

- The hob is supplied with a connection cable.
- To replace the damaged mains cable, use the cable type: H05V2V2-F which withstands a temperature of 90 °C or higher. Speak to your local Service Centre.

4.4 Assembly

If you install the hob under a hood, please see the installation instructions of the hood for the minimum distance between the appliances.

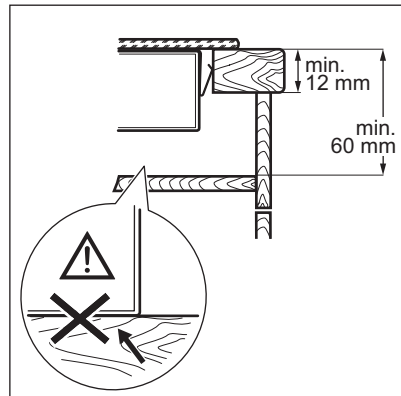
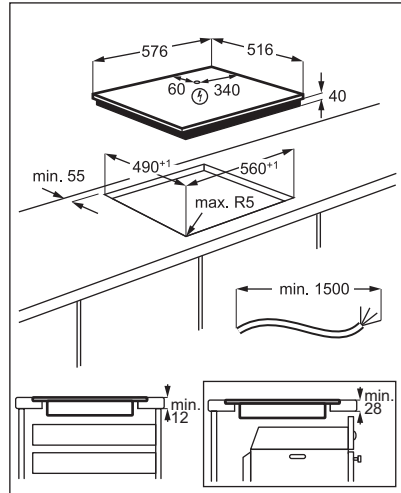
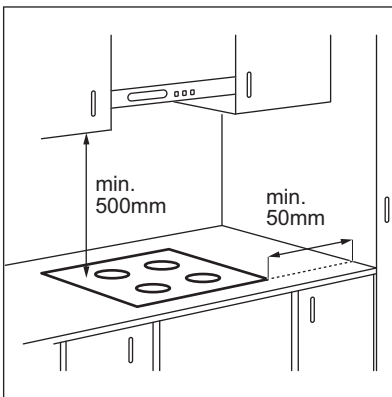

www.youtube.com/electrolux
www.youtube.com/aeg

How to install your AEG
Radiant Hob - Worktop installation



4.5 Protection box

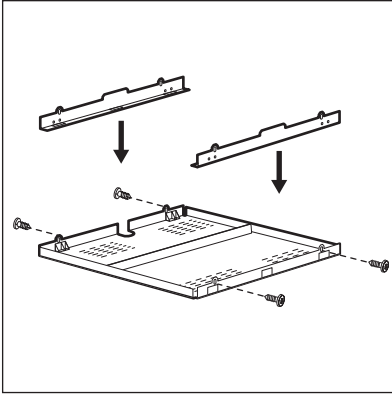

If you use a protection box (an additional accessory), the protective floor directly below the hob is not necessary. The protection box accessory may not be available in some countries. Please contact your local supplier.



You cannot use the protection box if you install the hob above an oven.

5. PRODUCT DESCRIPTION

5.1 Cooking surface layout

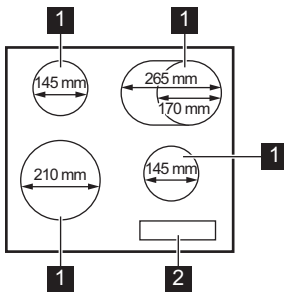





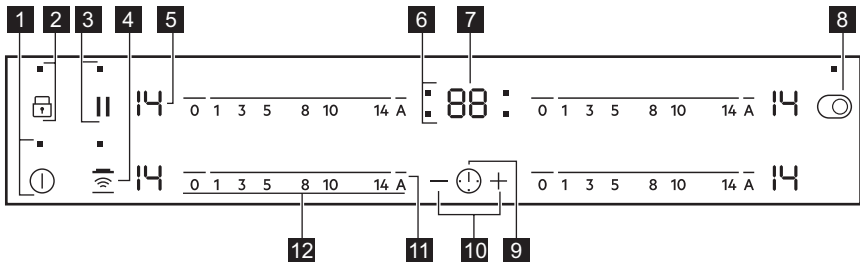

- 1** Cooking zone
- 2** Control panel











5.2 Control panel layout



Use the sensor fields to operate the appliance. The displays, indicators and sounds tell which functions operate.

Sensor field	Function	Comment
1 	ON / OFF	To activate and deactivate the hob.
2 	Lock / Child Safety Device	To lock / unlock the control panel.
3 	Pause	To activate and deactivate the function.
4 	Hob²Hood	To activate and deactivate the manual mode of the function.
5 -	Heat setting display	To show the heat setting.
6 -	Timer indicators of cooking zones	To show for which zone you set the time.
7 -	Timer display	To show the time in minutes.
8 	-	To activate and deactivate the outer ring.
9 	-	To select the cooking zone.
10 + / -	-	To increase or decrease the time.
11 A	Automatic Heat Up	To activate and deactivate the function.
12 -	Control bar	To set a heat setting.

5.3 Heat setting displays

Display	Description
	The cooking zone is deactivated.
 - 	The cooking zone operates.
	Pause operates.
	Automatic Heat Up operates.
 + digit	There is a malfunction.
 /  / 	OptiHeat Control (3 step Residual heat indicator): continue cooking / keep warm / residual heat.
	Lock / Child Safety Device operates.
	Automatic Switch Off operates.

5.4 OptiHeat Control (3 step Residual heat indicator)



WARNING!

 There is a risk of burns from residual heat.

The indicators show the level of the residual heat for the cooking zones you are currently using. The indicators may also come on for the neighbouring cooking zones even if you are not using them.

6. DAILY USE



WARNING!

Refer to Safety chapters.

6.1 Activating and deactivating

Touch  for 1 second to activate or deactivate the hob.

6.2 Automatic Switch Off

The function deactivates the hob automatically if:

- all cooking zones are deactivated,
- you do not set the heat setting after you activate the hob,
- you spill something or put something on the control panel for more than 10 seconds (a pan, a cloth, etc.). An acoustic signal sounds and the hob deactivates. Remove the object or clean the control panel.
- you do not deactivate a cooking zone or change the heat setting. After some time  comes on and the hob deactivates.

The relation between the heat setting and the time after which the hob deactivates:

Heat setting	The hob deactivates after
 1 - 3	6 hours
4 - 7	5 hours
8 - 9	4 hours
10 - 14	1.5 hour

6.3 The heat setting

To set or change the heat setting:

Touch the control bar at the correct heat setting or move your finger along the control bar until you reach the correct heat setting.

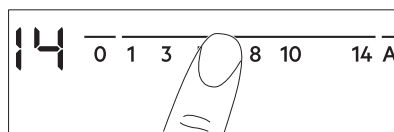

6.4 Activating and deactivating the outer rings

You can adjust the surface you cook to the dimension of the cookware.

Use sensor field: 

To activate the outer ring: touch the sensor field. The indicator comes on.



To deactivate the outer ring: touch the sensor field until the indicator goes out.

6.5 Automatic Heat Up

Activate this function to get a desired heat setting in a shorter time. When it is on, the zone operates on the highest setting in the beginning and then continues to cook at the desired heating setting.

 To activate the function the cooking zone must be cold.

To activate the function for a cooking

zone: touch **A** ( comes on). Immediately touch a desired heat setting. After 3 seconds  comes on.

To deactivate the function: change the heat setting.

6.6 Timer

• **Count Down Timer**



You can use this function to set the length of a single cooking session.



First set the heat setting for the cooking zone, then set the function.

To set the cooking zone: touch  repeatedly until the indicator of a cooking zone appears.

To activate the function: touch  of the timer to set the time (00 - 99 minutes). When the indicator of the cooking zone starts to flash, the time counts down.

To see the remaining time: touch  to set the cooking zone. The indicator of the cooking zone starts to flash. The display shows the remaining time.

To change the time: touch  to set the cooking zone. Touch  or .

To deactivate the function: touch  to set the cooking zone and then touch . The remaining time counts down to 00. The indicator of the cooking zone disappears.





When the countdown ends, an acoustic signal sounds and 00 flashes. The cooking zone deactivates.

To stop the sound: touch .



• CountUp Timer

You can use this function to monitor how long the cooking zone operates.

To set the cooking zone: touch  repeatedly until the indicator of a cooking zone appears.



To activate the function: touch  of the timer.  appears. When the indicator of the cooking zone starts to flash, the time counts up. The display switches between  and the counted time (in minutes).

To see how long the cooking zone operates: touch  to set the cooking zone. The indicator of the cooking zone starts to flash. The display shows how long the zone operates.

To deactivate the function: touch  and then touch  or . The indicator of the cooking zone disappears.

• Minute Minder

You can use this function when the hob is activated and the cooking zones do not operate. The heat setting display shows .

To activate the function: touch  and then touch  or  of the timer to set the time. When the time finishes, an acoustic signal sounds and 00 flashes.

To stop the sound: touch .



The function has no effect on the operation of the cooking zones.

6.7 Pause

This function sets all cooking zones that operate to the lowest heat setting.

When the function operates, all other symbols on the control panels are locked.

The function does not stop the timer functions.

Touch  to activate the function.



 comes on. The heat setting is lowered to 1.

To deactivate the function, touch . The previous heat setting comes on.

6.8 Lock

You can lock the control panel while cooking zones operate. It prevents an accidental change of the heat setting.

Set the heat setting first.

To activate the function: touch   comes on for 4 seconds. The Timer stays on.

To deactivate the function: touch . The previous heat setting comes on.



When you deactivate the hob, you also deactivate this function.

6.9 Child Safety Device

This function prevents an accidental operation of the hob.

To activate the function: activate the hob with . Do not set any heat setting. Touch

⏏ for 4 seconds. ⏏ comes on. Deactivate the hob with ⏏.

To deactivate the function: activate the hob with ⏏. Do not set any heat setting. Touch ⏏ for 4 seconds. ⏏ comes on. Deactivate the hob with ⏏.

To override the function for only one cooking time: activate the hob with ⏏. ⏏ comes on. Touch ⏏ for 4 seconds. **Set the heat setting in 10 seconds.** You can operate the hob. When you deactivate the hob with ⏏ the function operates again.

6.10 OffSound Control (Deactivating and activating the sounds)

Deactivate the hob. Touch ⏏ for 3 seconds. The display comes on and goes out. Touch ⏏ for 3 seconds. ⏏ or ⏏ comes on. Touch + of the timer to choose one of the following:

- ⏏ - the sounds are off
- ⏏ - the sounds are on

To confirm your selection wait until the hob deactivates automatically.

When the function is set to ⏏ you can hear the sounds only when:

- you touch ⏏
- Minute Minder comes down
- Count Down Timer comes down
- you put something on the control panel.

6.11 Power management

- Cooking zones are grouped according to the location and number of the phases in the hob. See the illustration.
- Each phase has a maximum electricity loading of 3700 W.
- The function divides the power between cooking zones connected to the same phase.
- The function activates when the total electricity loading of the cooking zones connected to a single phase exceeds 3700 W.

- The function decreases the power to the other cooking zones connected to the same phase.
- The heat setting display of the reduced zones alternates between the chosen heat setting and the reduced heat setting. After some time the heat setting display of the reduced zones stays on the reduced heat setting.

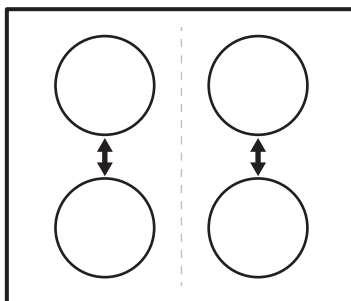

6.12 Hob²Hood

It is an advanced automatic function which connects the hob to a special hood. Both the hob and the hood have an infrared signal communicator. Speed of the fan is defined automatically on basis of mode setting and temperature of the hottest cookware on the hob. You can also operate the fan from the hob manually.

- **i** For most of the hoods the remote system is originally deactivated. Activate it before you use the function. For more information refer to hood user manual.

Operating the function automatically

To operate the function automatically set the automatic mode to H1 – H6. The hood reacts whenever you operate the hob. The hob recognizes temperature of the cookware automatically and adjusts the speed of the fan.

Automatic modes

	Automatic light	Boiling ¹⁾	Frying ²⁾
Mode H0	Off	Off	Off





	Automatic light	Boiling ¹⁾	Frying ²⁾
Mode H1	On	Off	Off
Mode H2 ³⁾	On	Fan speed 1	Fan speed 1
Mode H3	On	Off	Fan speed 1
Mode H4	On	Fan speed 1	Fan speed 1
Mode H5	On	Fan speed 1	Fan speed 2
Mode H6	On	Fan speed 2	Fan speed 3

1) The hob detects the boiling process and activates fan speed in accordance with automatic mode.

2) The hob detects the frying process and activates fan speed in accordance with automatic mode.

3) This mode activates the fan and the light and does not rely on the temperature.

Changing the automatic mode





1. Deactivate the appliance.
2. Touch  for 3 seconds. The display comes on and goes off.
3. Touch  for 3 seconds.
4. Touch  a few times until  comes on.
5. Touch  of the Timer to select an automatic mode.

 To operate the hood directly on the hood panel deactivate the automatic mode of the function.

 When you finish cooking and deactivate the hob, the hood fan may still operate for a certain period of time. After that time the system deactivates the fan automatically and prevents you from accidental activation of the fan for the next 30 seconds.

Operating the fan speed manually

You can also operate the function manually.

To do that touch  when the hob is active. This deactivates automatic operation of the function and allows you to change the fan speed manually. When you press  you raise the fan speed by one. When you reach an intensive level and press  again you will set fan speed to 0 which deactivates the hood fan. To start the fan again with fan speed 1 touch .

 To activate automatic operation of the function, deactivate the hob and activate it again.

Activating the light

You can set the hob to activate the light automatically whenever you activate the hob. To do so set the automatic mode to H1 – H6.

 The light on the hood deactivates 2 minutes after deactivating the hob.

7. HINTS AND TIPS



WARNING!
Refer to Safety chapters.

7.1 Cookware

- The bottom of the cookware must be as thick and flat as possible.
- Ensure pan bases are clean and dry before placing on the hob surface.
- In order to avoid scratches, do not slide or rub the pot across the ceramic glass.



Cookware made of enamelled steel and with aluminium or copper bottoms can cause a colour change on the glass-ceramic surface.

7.2 Öko Timer (Eco Timer)

To save energy, the heater of the cooking zone deactivates before the count down timer sounds. The difference in the operation

time depends on the heat setting level and the length of the cooking operation.

7.3 Examples of cooking applications



The data in the table is for guidance only.

Heat setting	Use to:	Time (min)	Hints
☐ - 1	Keep cooked food warm.	as necessary	Put a lid on the cookware.
1 - 3	Hollandaise sauce, melt: butter, chocolate, gelatine.	5 - 25	Mix from time to time.
1 - 3	Solidify: fluffy omelettes, baked eggs.	10 - 40	Cook with a lid on.
3 - 5	Simmer rice and milkbased dishes, heat up ready-cooked meals.	25 - 50	Add at least twice as much liquid as rice, mix milk dishes halfway through the procedure.
5 - 7	Steam vegetables, fish, meat.	20 - 45	Add a couple of tablespoons of liquid.
7 - 9	Steam potatoes.	20 - 60	Use max. ¼ l of water for 750 g of potatoes.
7 - 9	Cook larger quantities of food, stews and soups.	60 - 150	Up to 3 l of liquid plus ingredients.
9 - 12	Gentle fry: escalope, veal cordon bleu, cutlets, rissoles, sausages, liver, roux, eggs, pancakes, doughnuts.	as necessary	Turn halfway through.
12 - 13	Heavy fry, hash browns, loin steaks, steaks.	5 - 15	Turn halfway through.
14	Boil water, cook pasta, sear meat (goulash, pot roast), deep-fry chips.		

7.4 Hints and Tips for Hob²Hood

When you operate the hob with the function:

- Protect the hood panel from direct sunlight.
- Do not spot halogen light on the hood panel.
- Do not cover the hob control panel.
- Do not interrupt the signal between the hob and the hood (e.g. with the hand, a cookware handle or a tall pot). See the picture.

The hood in the picture is only exemplary.

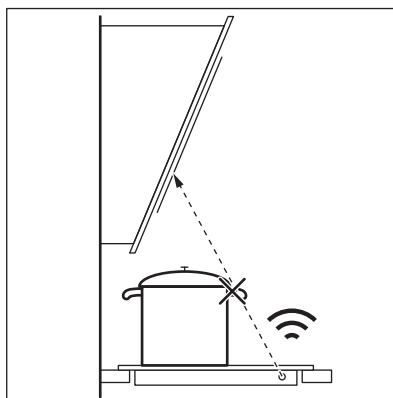



Other remotely controlled appliances may block the signal. Do not use any such appliances near to the hob while Hob²Hood is on.

Cooker hoods with the Hob²Hood function

To find the full range of cooker hoods which work with this function refer to our consumer website. The AEG cooker hoods that work with this function must have the symbol

8. CARE AND CLEANING



WARNING!
Refer to Safety chapters.

8.1 General information

- Clean the hob after each use.
- Always use cookware with a clean base.
- Scratches or dark stains on the surface have no effect on how the hob operates.
- Use a special cleaner suitable for the surface of the hob.
- Use a special scraper for the glass.

8.2 Cleaning the hob

- **Remove immediately:** melted plastic, plastic foil, sugar and food with sugar,

otherwise, the dirt can cause damage to the hob. Take care to avoid burns. Use a special hob scraper on the glass surface at an acute angle and move the blade on the surface.

- **Remove when the hob is sufficiently cool:** limescale rings, water rings, fat stains, shiny metallic discoloration. Clean the hob with a moist cloth and a non-abrasive detergent. After cleaning, wipe the hob dry with a soft cloth.
- **Remove shiny metallic discoloration:** use a solution of water with vinegar and clean the glass surface with a cloth.







9. TROUBLESHOOTING



WARNING!
Refer to Safety chapters.

9.1 What to do if...

Problem	Possible cause	Remedy
You cannot activate or operate the hob.	The hob is not connected to an electrical supply or it is connected incorrectly.	Check if the hob is correctly connected to the electrical supply.
	The fuse is blown.	Make sure that the fuse is the cause of the malfunction. If the fuse is blown again and again, contact a qualified electrician.
	You do not set the heat setting for 10 seconds.	Activate the hob again and set the heat setting in less than 10 seconds.
	You touched 2 or more sensor fields at the same time.	Touch only one sensor field.
	Pause operates.	Refer to "Daily use".

Problem	Possible cause	Remedy
	There is water or fat stains on the control panel.	Clean the control panel.
An acoustic signal sounds and the hob deactivates. An acoustic signal sounds when the hob is deactivated.	You put something on one or more sensor fields.	Remove the object from the sensor fields.
The hob deactivates.	You put something on the sensor field  .	Remove the object from the sensor field.
Residual heat indicator does not come on.	The zone is not hot because it operated only for a short time or the sensor is damaged.	If the zone operated sufficiently long to be hot, speak to an Authorised Service Centre.
Hob ² Hood does not work.	You covered the control panel.	Remove the object from the control panel.
	You use a very tall pot which blocks the signal.	Use a smaller pot, change the cooking zone or operate the hood manually.
Automatic Heat Up does not operate.	The zone is hot.	Let the zone become sufficiently cool.
	The highest heat setting is set.	The highest heat setting has the same power as the function.
You cannot activate the outer ring.		First, activate the inner ring by changing the heat setting.
 There is a dark area on the multiple zone.	It is normal that there is a dark area on the multiple zone.	
The heat setting changes between two levels.	Power management operates.	Refer to "Daily use".
The sensor fields become hot.	The cookware is too large or you put it too near to the controls.	Put large cookware on the rear zones, if possible.
There is no sound when you touch the panel sensor fields.	The sounds are deactivated.	Activate the sounds. Refer to "Daily use".
 comes on.	Child Safety Device or Lock operates.	Refer to "Daily use".
 and a number come on.	There is an error in the hob.	Deactivate the hob and activate it again after 30 seconds. If  comes on again, disconnect the hob from the electrical supply. After 30 seconds, connect the hob again. If the problem continues, speak to an Authorised Service Centre.
You can hear a constant beep noise.	The electrical connection is incorrect.	Disconnect the hob from the electrical supply. Ask a qualified electrician to check the installation.
 comes on.	The second phase of the power supply is missing.	Check if the hob is correctly connected to the electrical supply. Remove the fuse, wait one minute, and insert the fuse again.

9.2 If you cannot find a solution...

If you cannot find a solution to the problem yourself, contact your dealer or an Authorised Service Centre. Give the data from the rating plate. Give also three digit letter code for the glass ceramic (it is in the corner of the glass surface) and an error

message that comes on. Make sure, you operated the hob correctly. If not the servicing by a service technician or dealer will not be free of charge, also during the warranty period. The instructions about the Service Centre and conditions of guarantee are in the guarantee booklet.

10. TECHNICAL DATA

10.1 Rating plate

Model HK654850XB
Typ 60 HAD R1 AO

Ser.Nr.
AEG

PNC 949 597 107 02
220 - 240 V 50 - 60 Hz
Made in Germany
6.4 kW



10.2 Cooking zones specification

Cooking zone	Nominal Power (Max heat setting) [W]	Cooking zone diameter [mm]
Left front	3000	210
Left rear	1600	145
Right front	1600	145
Right rear	1800 / 2800	170 / 265

For optimal cooking results use cookware no larger than the diameter of the cooking zone.

11. ENERGY EFFICIENCY

11.1 Product information according to EU 66/2014 valid for EU market only

Model identification	HK654850XB	
Type of hob	Built-In Hob	
Number of cooking zones	4	
Heating technology	Radiant Heater	
Diameter of circular cooking zones (Ø)	Left front	21.0 cm
	Left rear	14.5 cm
	Right front	14.5 cm
Lenght (L) and width (W) of non circular cooking zone	Right rear	L 26.5 cm W 17.0 cm

Energy consumption per cooking zone (EC electric cooking)

Left front	194.8 Wh / kg
Left rear	190.4 Wh / kg
Right front	190.4 Wh / kg
Right rear	185.5 Wh / kg

Energy consumption of the hob (EC electric hob)

190.3 Wh / kg

EN 60350-2 - Household electric cooking appliances - Part 2: Hobs - Methods for measuring performance

11.2 Energy saving

You can save energy during everyday cooking if you follow below hints.

- When you heat up water, use only the amount you need.
- If it is possible, always put the lids on the cookware.

- Before you activate the cooking zone put the cookware on it.
- The cookware bottom should have the same diameter as the cooking zone.
- Put the smaller cookware on the smaller cooking zones.
- Put the cookware directly in the centre of the cooking zone.
- Use the residual heat to keep the food warm or to melt it.

12. WARRANTY

FOR SALES IN AUSTRALIA AND NEW ZEALAND

ALL AEG BRANDED APPLIANCES

This document sets out the terms and conditions of the product warranties for AEG Appliances. It is an important document. Please keep it with your proof of purchase documents in a safe place for future reference should there be a manufacturing defect in your Appliance. This warranty is in addition to other rights you may have under the Australian Consumer Law.

1. In this warranty:

- a) 'ACL' or 'Australian Consumer Law' means Schedule 2 to the Competition and Consumer Act 2010;
- b) 'Appliance' means any Electrolux product purchased by you and accompanied by this document;
- c) 'ASC' means Electrolux's authorised serviced centres;
- d) 'AEG' is the brand controlled by Electrolux Home Products Pty Ltd of 163 O'Riordan Street, Mascot NSW 2020, ABN 51 004 762 341 in respect of Appliances purchased in Australia and Electrolux (NZ) Limited (collectively "Electrolux") of 3-5 Niall Burgess Road, Mount Wellington, in

respect of Appliances purchased in New Zealand;

- e) 'Warranty Period' means the period specified in clause 3 of this warranty;
 - f) 'you' means the purchaser of the Appliance not having purchased the Appliance for re-sale, and 'your' has a corresponding meaning.
2. **Application:** This warranty only applies to new Appliances, purchased and used in Australia or New Zealand and is in addition to (and does not exclude, restrict, or modify in any way) other rights and remedies under a law to which the Appliances or services relate, including any non-excludable statutory guarantees in Australia and New Zealand.
 3. **Warranty Period:** Subject to these terms and conditions, this warranty continues for in Australia for a period of 60 months and in New Zealand for a period of 60 months, following the date of original purchase of the Appliance.
 4. **Repair or replace warranty:** During the Warranty Period, Electrolux or its ASC will, at no extra charge if your Appliance is readily accessible for service, without special equipment and subject to these terms and conditions, repair or replace any parts which it considers to be defective. Electrolux may, in its absolute discretion, choose whether the remedy

offered for a valid warranty claim is repair or replacement. Electrolux or its ASC may use refurbished parts to repair your Appliance. You agree that any replaced Appliances or parts become the property of Electrolux.

5. Travel and transportation costs:

Subject to clause 7, Electrolux will bear the reasonable cost of transportation, travel and delivery of the Appliance to and from Electrolux or its ASC. Travel and transportation will be arranged by Electrolux as part of any valid warranty claim.

6. Proof of purchase is required before you can make a claim under this warranty.

7. Exclusions: You may not make a claim under this warranty unless the defect claimed is due to faulty or defective parts or workmanship. This warranty does not cover:

- a) light globes, batteries, filters or similar perishable parts;
- b) parts and Appliances not supplied by Electrolux;
- c) cosmetic damage which does not affect the operation of the Appliance;
- d) damage to the Appliance caused by:
 - negligence or accident;
 - misuse or abuse, including failure to properly maintain or service;
 - improper, negligent or faulty servicing or repair works done by anyone other than an Electrolux authorised repairer or ASC;
 - normal wear and tear;
 - power surges, electrical storm damage or incorrect power supply;
 - incomplete or improper installation;
 - incorrect, improper or inappropriate operation;
 - insect or vermin infestation;
 - failure to comply with any additional instructions supplied with the Appliance;

In addition, Electrolux is not liable under this warranty if:

- the Appliance has been, or Electrolux reasonably believes that the Appliance has been, used for purposes other than those for

which the Appliance was intended, including where the Appliance has been used for any non-domestic purpose;

- the Appliance is modified without authority from Electrolux in writing;
- the Appliance's serial number or warranty seal has been removed or defaced.

8. How to claim under this warranty: To enquire about claiming under this warranty, please follow these steps:

- a. carefully check the operating instructions, user manual and the terms of this warranty;
- b. have the model and serial number of the Appliance available;
- c. have the proof of purchase (e.g. an invoice) available;
- d. telephone the numbers shown below.

9. Australia: For Appliances and services provided by Electrolux in Australia: Electrolux goods come with guarantees that cannot be excluded under the Australian Consumer Law. You are entitled to a replacement or refund for a major failure and for compensation for any other reasonably foreseeable loss or damage. You are also entitled to have the Appliance repaired or replaced if the Appliance fails to be of acceptable quality and the failure does not amount to a major failure. 'Acceptable quality' and 'major failure' have the same meaning as referred to in the ACL.

10. New Zealand: For Appliances and services provided by Electrolux in New Zealand, the Appliances come with a guarantee by Electrolux pursuant to the provisions of the Consumer Guarantees Act, the Sale of Goods Act and the Fair Trading Act. Where the Appliance was purchased in New Zealand for commercial purposes the Consumer Guarantee Act does not apply.

11. Confidentiality: You accept that if you make a warranty claim, Electrolux and its agents including ASC may exchange information in relation to you to enable Electrolux to meet its obligations under this warranty.

Important Notice

Before calling for service, please ensure that the steps listed in clause 8 above have been followed.

SERVICE AUSTRALIA aeg.com/au

FOR SERVICE

or to find the address of your nearest authorised service centre in Australia

PLEASE CALL 1300 363 664

OR EMAIL

customercare@aegaustralia.com.au

For the cost of a local call (Australia only)

FOR SPARE PARTS

or to find the address of your nearest spare parts centre in Australia

PLEASE CALL 13 13 50

OR EMAIL

customercare@aegaustralia.com.au

For the cost of a local call (Australia only)

SERVICE NEW ZEALAND aegnewzealand.co.nz

FOR SERVICE

or to find the address of your nearest authorised service centre in New Zealand

PLEASE CALL 0800 234 234

OR EMAIL

customercare@electrolux.co.nz

(New Zealand only)

FOR SPARE PARTS

or to find the address of your nearest spare parts centre in New Zealand

PLEASE CALL 0800 10 66 20

OR EMAIL

customercare@electrolux.co.nz

(New Zealand only)

AEG_Warr_May_17

13. ENVIRONMENTAL CONCERNS

Recycle materials with the symbol . Put the packaging in relevant containers to recycle it. Help protect the environment and human health by recycling waste of electrical and electronic appliances. Do not dispose of

appliances marked with the symbol  with the household waste. Return the product to your local recycling facility or contact your municipal office.

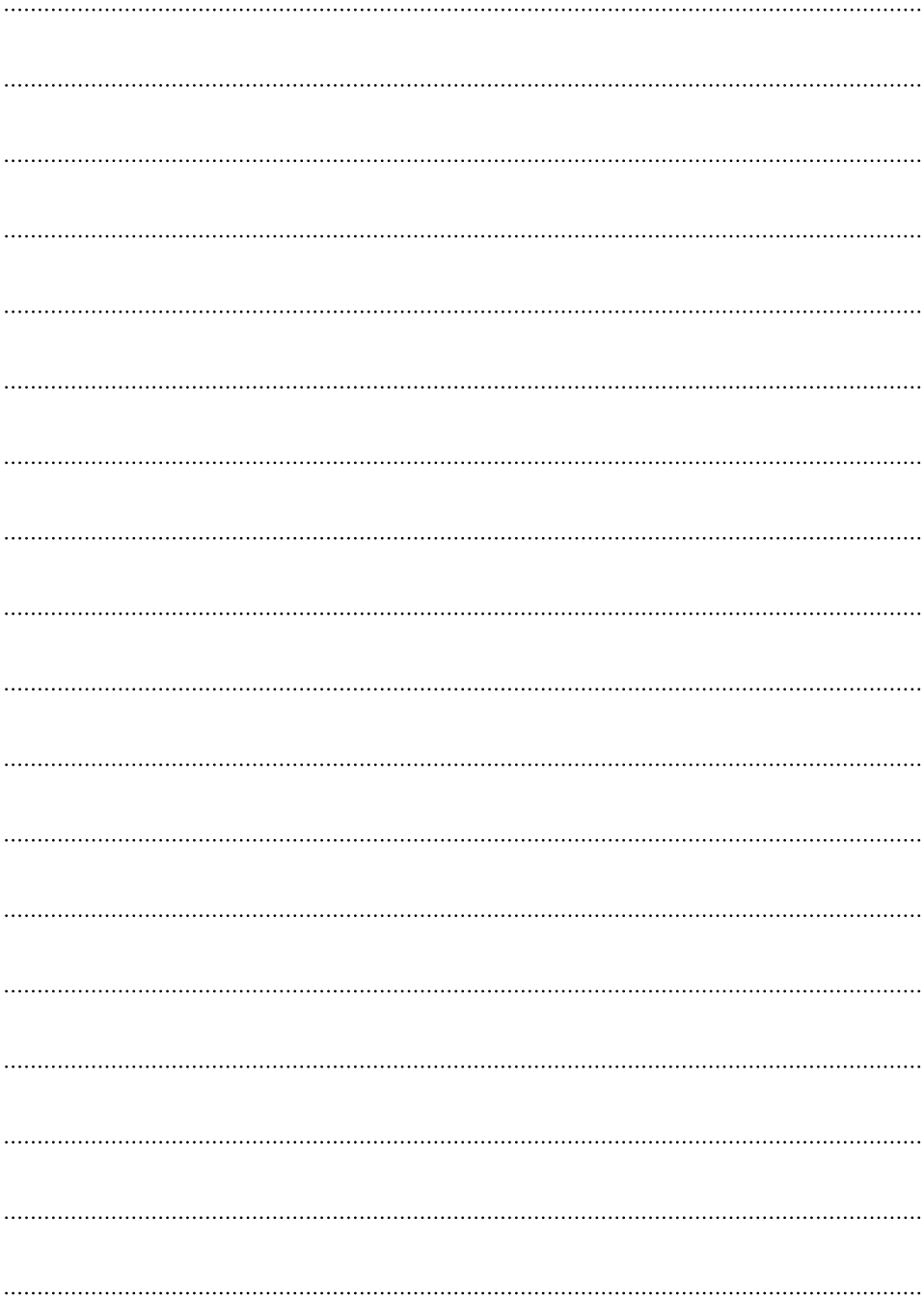

A series of 20 horizontal dotted lines spanning the width of the page, intended for writing or drawing.

.....

.....

.....

.....

.....

.....

.....

.....

.....

.....

.....

.....

.....

.....

.....

.....

.....

.....

.....

.....

.....

.....

.....

.....

.....

.....

www.aeg.com/au

867358455-A-252020



AEG