



CONTENTS

1. SAFETY INFORMATION.....	3
2. CONDITIONS OF USE.....	4
3. SAFETY INSTRUCTIONS.....	4
4. PRODUCT DESCRIPTION.....	6
5. DAILY USE.....	8
6. HINTS AND TIPS.....	10
7. CARE AND CLEANING.....	11
8. TROUBLESHOOTING.....	12
9. INSTALLATION.....	13
10. TECHNICAL INFORMATION.....	15
11. ENERGY EFFICIENCY.....	15
12. WARRANTY	16

FOR PERFECT RESULTS

Thank you for choosing this AEG product. We have created it to give you impeccable performance for many years, with innovative technologies that help make life simpler features you might not find on ordinary appliances. Please spend a few minutes reading to get the very best from it.

Visit our website for:



Get usage advice, brochures, trouble shooter, service information:
www.aeg.com



Register your product for better service:
www.registeraeg.com

CUSTOMER CARE AND SERVICE

Always use original spare parts.

When contacting our Authorised Service Centre, ensure that you have the following data available: Model, PNC, Serial Number.

The information can be found on the rating plate.



Warning / Caution-Safety information



General information and tips



Environmental information

Subject to change without notice.

1. SAFETY INFORMATION

Before the installation and use of the appliance, carefully read the supplied instructions. The manufacturer is not responsible if an incorrect installation and use causes injuries and damages. Always keep the instructions with the appliance for future reference.

1.1 Children and vulnerable people safety

- This appliance can be used by children aged from 8 years and above and persons with reduced physical, sensory or mental capabilities or lack of experience and knowledge if they have been given supervision or instruction concerning use of the appliance in a safe way and understand the hazards involved.
- Do not let children play with the appliance.
- Keep all packaging away from children.
- Keep children and pets away from the appliance when it operates or when it cools down. Accessible parts are hot.
- If the appliance has a child safety device, we recommend you activate it.
- Cleaning and user maintenance shall not be made by children without supervision.
- Children of less than 3 years should be kept away unless continuously supervised.

1.2 General Safety

- The appliance and its accessible parts become hot during use. Do not touch the heating elements.
- Do not operate the appliance by means of an external timer or separate remote-control system.
- Unattended cooking on a hob with fat or oil can be dangerous and may result in fire.
- Never try to extinguish a fire with water, but switch off the appliance and then cover flame e.g. with a lid or a fire blanket.

- Do not store items on the cooking surfaces.
- Metallic objects such as knives, forks, spoons and lids should not be placed on the hob surface since they can get hot.
- Do not use a steam cleaner to clean the appliance.
- If the glass ceramic surface / glass surface is cracked, switch off the appliance to avoid the possibility of electric shock.
- If the supply cord is damaged, it must be replaced by the manufacturer, an authorized Service or similarly qualified persons in order to avoid a hazard.

2. CONDITIONS OF USE

This appliance is intended to be used in household and similar applications such as:

- Farm houses

- By clients in serviced apartments, holiday apartments and other residential type environments.

3. SAFETY INSTRUCTIONS

3.1 Installation



WARNING!

Only a qualified person must install this appliance.

- Remove all the packaging.
- Do not install or use a damaged appliance.
- Obey the installation instruction supplied with the appliance.
- Keep the minimum distance from the other appliances and units.
- Always be careful when you move the appliance because it is heavy. Always wear safety gloves.
- Seal the cut surfaces with a sealant to prevent moisture to cause swelling.
- Protect the bottom of the appliance from steam and moisture.
- Do not install the appliance adjacent to a door or under a window. This prevents hot cookware to fall from the appliance when the door or the window is opened.
- If the appliance is installed above drawers make sure that the space, between the bottom of the appliance

and the upper drawer, is sufficient for air circulation.

- The bottom of the appliance can get hot. Make sure to install a non-combustible separation panel under the appliance to prevent access to the bottom.

3.2 Electrical Connection



WARNING!

Risk of fire and electrical shock.

- All electrical connections should be made by a qualified electrician.
- The appliance must be earthed.
- Before carrying out any operation make sure that the appliance is disconnected from the power supply.
- Make sure that the electrical information on the rating plate agrees with the power supply. If not, contact an electrician.
- Make sure the appliance is installed correctly. Loose and incorrect electricity mains cable or plug (if applicable) can make the terminal become too hot.

- Use the correct electricity mains cable.
- Do not let the electricity mains cable tangle.
- Make sure that a shock protection is installed.
- Use the strain relief clamp on the cable.
- Make sure the mains cable or plug (if applicable) does not touch the hot appliance or hot cookware, when you connect the appliance to the near sockets
- Do not use multi-plug adapters and extension cables.
- Make sure not to cause damage to the mains plug (if applicable) or to the mains cable. Contact our Authorised Service Centre or an electrician to change a damaged mains cable.
- The shock protection of live and insulated parts must be fastened in such a way that it cannot be removed without tools.
- Connect the mains plug to the mains socket only at the end of the installation. Make sure that there is access to the mains plug after the installation.
- If the mains socket is loose, do not connect the mains plug.
- Do not pull the mains cable to disconnect the appliance. Always pull the mains plug.
- Use only correct isolation devices: line protecting cut-outs, fuses (screw type fuses removed from the holder), earth leakage trips and contactors.
- The electrical installation must have an isolation device which lets you disconnect the appliance from the mains at all poles. The isolation device must have a contact opening width of minimum 3 mm.
- Do not change the specification of this appliance.
- Make sure that the ventilation openings are not blocked.
- Do not let the appliance stay unattended during operation.
- Set the cooking zone to "off" after each use.
- Do not put cutlery or saucepan lids on the cooking zones. They can become hot.
- Do not operate the appliance with wet hands or when it has contact with water.
- Do not use the appliance as a work surface or as a storage surface.
- If the surface of the appliance is cracked, disconnect immediately the appliance from the power supply. This to prevent an electrical shock.
- When you place food into hot oil, it may splash.

**WARNING!**

Risk of fire and explosion

- Fats and oil when heated can release flammable vapours. Keep flames or heated objects away from fats and oils when you cook with them.
- The vapours that very hot oil releases can cause spontaneous combustion.
- Used oil, that can contain food remnants, can cause fire at a lower temperature than oil used for the first time.
- Do not put flammable products or items that are wet with flammable products in, near or on the appliance.

**WARNING!**

Risk of damage to the appliance.

- Do not keep hot cookware on the control panel.
- Do not let cookware to boil dry.
- Be careful not to let objects or cookware fall on the appliance. The surface can be damaged.
- Do not activate the cooking zones with empty cookware or without cookware.
- Do not put aluminium foil on the appliance.
- Cookware made of cast iron, aluminium or with a damaged bottom

3.3 Use

**WARNING!**

Risk of injury, burns and electrical shock.

- Remove all the packaging, labelling and protective film (if applicable) before first use.
- Use this appliance in a household environment.

can cause scratches on the glass / glass ceramic. Always lift these objects up when you have to move them on the cooking surface.

- This appliance is for cooking purposes only. It must not be used for other purposes, for example room heating.

3.4 Care and cleaning

- Clean regularly the appliance to prevent the deterioration of the surface material.
- Deactivate the appliance and let it cool down before you clean it.
- Disconnect the appliance from the electrical supply before maintenance.
- Do not use water spray and steam to clean the appliance.
- Clean the appliance with a moist soft cloth. Only use neutral detergents. Do

not use abrasive products, abrasive cleaning pads, solvents or metal objects.

3.5 Disposal



WARNING!

Risk of injury or suffocation.

- Contact your municipal authority for information on how to discard the appliance correctly.
- Disconnect the appliance from the mains supply.
- Cut off the mains cable and discard it.

3.6 Service

- To repair the appliance contact an Authorised Service Centre.
- Use original spare parts only.

4. PRODUCT DESCRIPTION

4.1 Cooking surface layout

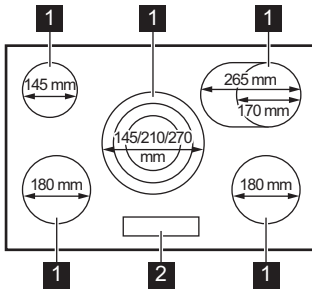





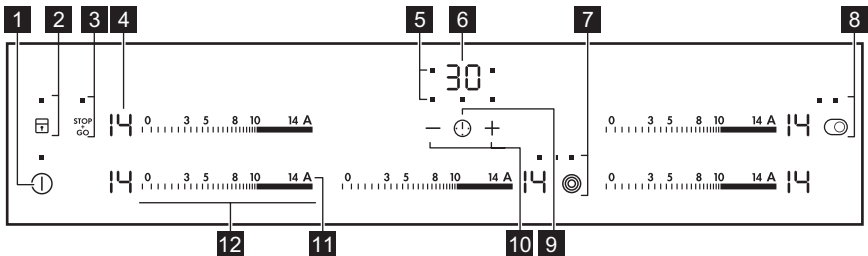



- 1 Cooking zone
- 2 Control panel









4.2 Control panel layout



Use the sensor fields to operate the appliance. The displays, indicators and sounds tell which functions operate.

	Sensor field	Function	Comment
1		ON / OFF	To activate and deactivate the hob.
2		Lock / The Child Safety Device	To lock / unlock the control panel.
3		STOP+GO	To activate and deactivate the function.
4	-	Heat setting display	To show the heat setting.
5	-	Timer indicators of cooking zones	To show for which zone you set the time.
6	-	Timer display	To show the time in minutes.
7		-	To activate and deactivate the outer ring.
8		-	To activate and deactivate the outer ring.
9		-	To select the cooking zone.
10		-	To increase or decrease the time.
11		Automatic Heat Up	To activate and deactivate the function.
12	-	Control bar	To set a heat setting.

4.3 Heat setting displays

Display	Description
	The cooking zone is deactivated.
	The cooking zone operates.
	STOP+GO function operates.
	Automatic Heat Up function operates.
	There is a malfunction.
	OptiHeat Control (3 step Residual heat indicator): continue cooking / keep warm / residual heat.
	Lock / The Child Safety Device function operates.
	Automatic Switch Off function operates.

4.4 OptiHeat Control (3 step Residual heat indicator)



WARNING!

There is a risk of burns from residual heat. The indicator shows the level of the residual heat.

5. DAILY USE



WARNING!

Refer to Safety chapters.

5.1 Activating and deactivating

Touch for 1 second to activate or deactivate the hob.

5.2 Automatic Switch Off

The function deactivates the hob automatically if:

- all cooking zones are deactivated,
- you do not set the heat setting after you activate the hob,
- you spill something or put something on the control panel for more than 10 seconds (a pan, a cloth, etc.). An acoustic signal sounds and the hob deactivates. Remove the object or clean the control panel.
- you do not deactivate a cooking zone or change the heat setting. After some time comes on and the hob deactivates.

The relation between the heat setting and the time after which the hob deactivates:

Heat setting	The hob deactivates after
1 - 3	6 hours
4 - 7	5 hours
8 - 9	4 hours
10 - 14	1.5 hour

5.3 The heat setting

To set or change the heat setting:

Touch the control bar at the correct heat setting or move your finger along the control bar until you reach the correct heat setting.

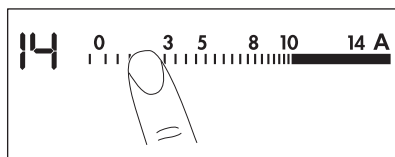

5.4 Activating and deactivating the outer rings

You can adjust the surface you cook to the dimension of the cookware.

Use sensor field:

To activate the outer ring: touch the sensor field. The indicator comes on.

To activate more outer rings: touch the same sensor field again. The subsequent indicator comes on.

To deactivate the outer ring: touch the sensor field until the indicator goes out.



When you activate the zone but do not activate the outer ring the light that comes out from the zone may cover the outer ring. It does not mean that the outer ring is activated. To see if the ring is activated check the indicator.

5.5 Automatic Heat Up

If you activate this function you can get a necessary heat setting in a shorter time. The function sets the highest heat setting for some time and then decreases to the correct heat setting.

 To activate the function the cooking zone must be cold.

To activate the function for a cooking zone: touch **A** ( comes on).

Immediately touch the correct heat setting. After 3 seconds ( comes on).

To deactivate the function: change the heat setting.

5.6 Timer

Count Down Timer



You can use this function to set how long the cooking zone should operate for a single cooking session.



First set the cooking zone then set the function. You can set the heat setting before or after you set the function.

To set the cooking zone: touch  again and again until the indicator of a necessary cooking zone comes on.

To activate the function: touch  of the timer to set the time (00 - 99 minutes). When the indicator of the cooking zone starts to flash slowly the time counts down.

To see the remaining time: set the cooking zone with . The indicator of the cooking zone starts to flash quickly. The display shows the remaining time.

To change the time: set the cooking zone with . Touch  or .

To deactivate the function: set the cooking zone with  and touch . The remaining time counts back to 00. The indicator of the cooking zone goes out.



 When the time comes to an end, the sound operates and 00 flashes. The cooking zone deactivates.

To stop the sound: touch .



CountUp Timer (The count up timer)

You can use this function to monitor how long the cooking zone operates.

To set the cooking zone: touch  again and again until the indicator of a necessary cooking zone comes on.

To activate the function: touch  of the timer.  comes on. When the indicator of the cooking zone starts to flash slowly the time counts up. The display switches between  and counted time (minutes).



To see how long the cooking zone operates: set the cooking zone with . The indicator of the cooking zone starts to flash quickly. The display shows how long the zone operates.

To deactivate the function: set the cooking zone with  and touch  or . The indicator of the cooking zone goes out.

Minute Minder

You can use this function as a **Minute Minder** when the hob is activated and the cooking zones do not operate (the heat setting display shows .

To activate the function: touch .

Touch  or  of the timer to set the time. When the time comes to an end, the sound operates and 00 flashes.

To stop the sound: touch .

 The function has no effect on the operation of the cooking zones.

5.7 STOP+GO

This function sets all cooking zones that operate to the lowest heat setting.

When the function operates, you cannot change the heat setting.

The function does not stop the timer functions.



To activate the function: touch  comes on.

To deactivate the function: touch . The previous heat setting comes on.

5.8 Lock

You can lock the control panel while cooking zones operate. It prevents an accidental change of the heat setting.

Set the heat setting first.





To activate the function: touch   comes on for 4 seconds. The Timer stays on.





To deactivate the function: touch . The previous heat setting comes on.

 When you deactivate the hob, you also deactivate this function.



5.9 The Child Safety Device

This function prevents an accidental operation of the hob.





To activate the function: activate the hob with . Do not set the heat setting. Touch  for 4 seconds.  comes on. Deactivate the hob with .



To deactivate the function: activate the hob with . Do not set the heat setting. Touch  for 4 seconds.  comes on. Deactivate the hob with .

To override the function for only one cooking time: activate the hob with .

 comes on. Touch  for 4 seconds. **Set the heat setting in 10 seconds.** You can operate the hob. When you deactivate the hob with  the function operates again.

5.10 OffSound Control (Deactivation and activation of the sounds)

Deactivate the hob. Touch  for 3 seconds. The display comes on and goes out. Touch  for 3 seconds.  or  comes on. Touch  of the timer to choose one of the following:

-  - the sounds are off
-  - the sounds are on

To confirm your selection wait until the hob deactivates automatically.

When the function is set to  you can hear the sounds only when:

- you touch 
- Minute Minder comes down
- Count Down Timer comes down
- you put something on the control panel.

6. HINTS AND TIPS

 **WARNING!**
Refer to Safety chapters.

6.1 Cookware

 The bottom of the cookware must be as thick and flat as possible.

 Cookware made of enamelled steel and with aluminium or copper bottoms can cause the colour change on the glass-ceramic surface.

6.2 Öko Timer (Eco Timer)

To save energy, the heater of the cooking zone deactivates before the count down timer sounds. The difference in the operation time depends on the heat setting level and the length of the cooking operation.

6.3 Examples of cooking applications

 The data in the table is for guidance only.

Heat setting	Use to:	Time (min)	Hints
 - 1	Keep cooked food warm.	as necessary	Put a lid on the cookware.
1 - 3	Hollandaise sauce, melt: butter, chocolate, gelatine.	5 - 25	Mix from time to time.
1 - 3	Solidify: fluffy omelettes, baked eggs.	10 - 40	Cook with a lid on.
3 - 5	Simmer rice and milkbased dishes, heating up ready-cooked meals.	25 - 50	Add the minimum twice as much liquid as rice, mix milk dishes part procedure through.
5 - 7	Steam vegetables, fish, meat.	20 - 45	Add some tablespoons of liquid.
7 - 9	Steam potatoes.	20 - 60	Use max. ¼ l water for 750 g of potatoes.
7 - 9	Cook larger quantities of food, stews and soups.	60 - 150	Up to 3 l liquid plus ingredients.
9 - 12	Gentle fry: escalope, veal cordon bleu, cutlets, rissoles, sausages, liver, roux, eggs, pancakes, doughnuts.	as necessary	Turn halfway through.
12 - 13	Heavy fry, hash browns, loin steaks, steaks.	5 - 15	Turn halfway through.
14	Boil water, cook pasta, sear meat (goulash, pot roast), deep-fry chips.		

7. CARE AND CLEANING



WARNING!

Refer to Safety chapters.

7.1 General information

- Clean the hob after each use.
- Always use cookware with clean bottom.
- Scratches or dark stains on the surface have no effect on how the hob operates.
- Use a special cleaner applicable for the surface of the hob.
- Use a special scraper for the glass.

7.2 Cleaning the hob

- **Remove immediately:** melted plastic, plastic foil, and food with sugar. If not, the dirt can cause damage to the hob. Put the special scraper on the glass surface at an acute angle and move the blade on the surface.
- **Remove when the hob is sufficiently cool:** limescale rings, water rings, fat stains, shiny metallic discoloration. Clean the hob with a moist cloth and some detergent. After cleaning, rub the hob dry with a soft cloth.

8. TROUBLESHOOTING







WARNING!

Refer to Safety chapters.

8.1 What to do if...

Problem	Possible cause	Remedy
You cannot activate or operate the hob.	The hob is not connected to an electrical supply or it is connected incorrectly.	Check if the hob is correctly connected to the electrical supply. Refer to the connection diagram.
	The fuse is released.	Make sure that the fuse is the cause of the malfunction. If the fuse releases again and again, contact a qualified electrician.
		Activate the hob again and set the heat setting in less than 10 seconds.
	You touched 2 or more sensor fields at the same time.	Touch only one sensor field.
	STOP+GO function operates.	Refer to "Daily use" chapter.
	There is water or fat stains on the control panel.	Clean the control panel.
An acoustic signal sounds and the hob deactivates. An acoustic signal sounds when the hob is deactivated.	You put something on one or more sensor fields.	Remove the object from the sensor fields.
The hob deactivates.	You put something on the sensor field ①.	Remove the object from the sensor field.
Residual heat indicator does not come on.	The zone is not hot because it operated only for a short time.	If the zone operated sufficiently long to be hot, speak to an Authorised Service Centre.
Automatic Heat Up function does not operate.	The zone is hot.	Let the zone become sufficiently cool.
	The highest heat setting is set.	The highest heat setting has the same power as the function.
You cannot activate the outer ring.		Activate the inner ring first.

Problem	Possible cause	Remedy
 There is a dark area on the multiple zone.	It is normal that there is a dark area on the multiple zone.	
The sensor fields become hot.	The cookware is too large or you put it too near to the controls.	Put large cookware on the rear zones if possible.
There is no signal when you touch the panel sensor fields.	The signals are deactivated.	Activate the signals. Refer to "Daily use" chapter.
 comes on.	Automatic Switch Off operates.	Deactivate the hob and activate it again.
 comes on.	The Child Safety Device or the Lock function operates.	Refer to "Daily use" chapter.
 and a number come on.	There is an error in the hob.	Disconnect the hob from the electrical supply for some time. Disconnect the fuse from the electrical system of the house. Connect it again. If  comes on again, speak to an Authorised Service Centre.

8.2 If you cannot find a solution...

If you cannot find a solution to the problem yourself, contact your dealer or an Authorised Service Centre. Give the data from the rating plate. Give also three digit letter code for the glass ceramic (it is in the corner of the glass

surface) and an error message that comes on. Make sure, you operated the hob correctly. If not the servicing by a service technician or dealer will not be free of charge, also during the warranty period. The instructions about the Service Centre and conditions of guarantee are in the guarantee booklet.

9. INSTALLATION



WARNING!

Refer to Safety chapters.

9.1 Before the installation

Before you install the hob, write down the information bellow from the rating plate. The rating plate is on the bottom of the hob.

Serial number

9.2 Built-in hobs

Only use the built-in hobs after you assemble the hob into correct built-in units and work surfaces that align to the standards.

9.3 Connection cable

- The hob is supplied with a connection cable.
- To replace the damaged mains cable use the following (or higher) mains

cable type: H05BB-F Tmax 90°C.
 Speak to your local Service Centre.

9.4 Assembly

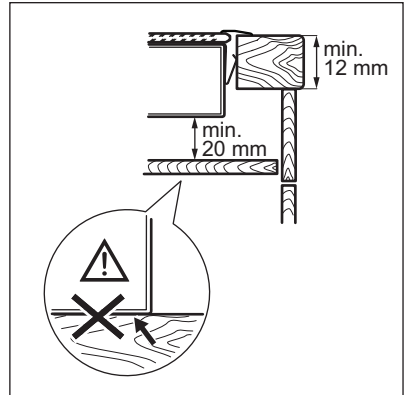
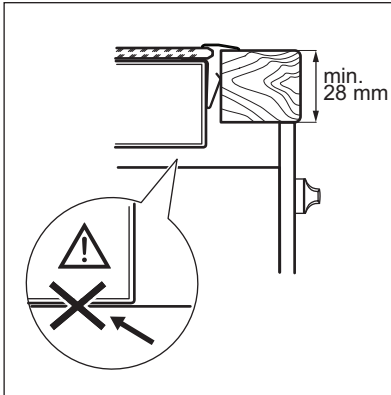
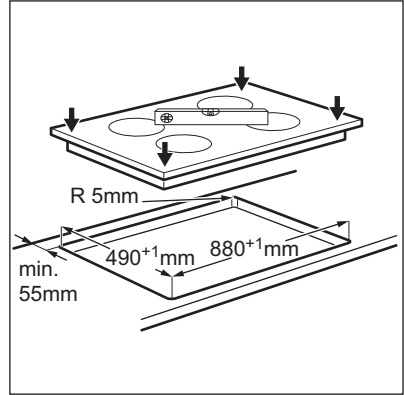
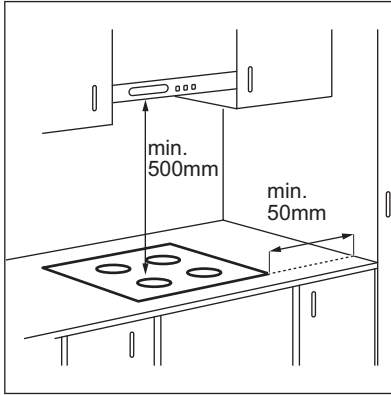

9.5 Protection box

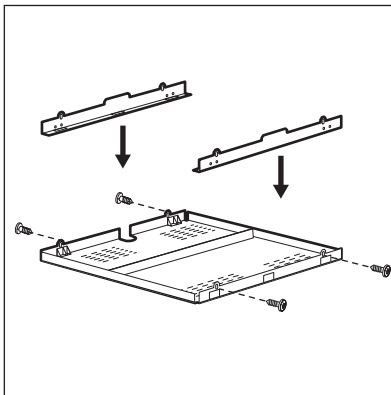

If you use a protection box (an additional accessory), the protective floor directly below the hob is not necessary. The protection box accessory may not be available in some countries. Please contact your local supplier.

i You can not use the protection box if you install the hob above an oven.

10. TECHNICAL INFORMATION

10.1 Rating plate

Modell HK955070XB
Typ 58 HCD AA AO

Ser.Nr.
AEG

PNC 949 595 020 01
220 - 240 V 50 - 60 Hz
Made in Germany
7.9 kW



10.2 Cooking zones specification

Cooking zone	Nominal Power (Max heat setting) [W]	Cooking zone diameter [mm]
Left front	1800	180
Left rear	1200	145
Middle rear	1050 / 1950 / 2700	145 / 210 / 270
Right front	1800	180
Right rear	1400 / 2200	170 / 265

For optimal cooking results use cookware not larger than the diameter of the cooking zone.

11. ENERGY EFFICIENCY

11.1 Product information according to EU 66/2014

Model identification	HK955070XB	
Type of hob	Built-In Hob	
Number of cooking zones	5	
Heating technology	Radiant Heater	
Diameter of circular cooking zones (Ø)	Left front	18.0 cm
	Left rear	14.5 cm
	Middle rear	27.0 cm
	Right front	18.0 cm
Length (L) and width (W) of non circular cooking zone	Right rear	L 17.0 cm W 26.5 cm
	Energy consumption per cooking zone (E _{electric cooking})	Left front Left rear Middle rear Right front Right rear

Energy consumption of the hob (EElectric hob)

181.0 Wh / kg

EN 60350-2 - Household electric cooking appliances - Part 2: Hobs - Methods for measuring performance

11.2 Energy saving

You can save energy during everyday cooking if you follow below hints.

- Put the cookware on the cooking zone before you activate it.
- The bottom of the cookware and the cooking zones should have the same dimension.

- Put smaller cookware on smaller cooking zones.
- Put the cookware directly in the centre of the cooking zone.
- When you heat up water use only the amount you need.
- If it is possible, put the lids on the cookware.
- Use the residual heat to keep the food warm or to melt it.

12. WARRANTY



FOR SALES IN AUSTRALIA AND NEW ZEALAND

ALL AEG BRANDED APPLIANCES

This document sets out the terms and conditions of the product warranties for AEG Appliances. It is an important document. Please keep it with your proof of purchase documents in a safe place for future reference should you require service for your Appliance.

- In this warranty
 - 'acceptable quality' as referred to in clause 10 of this warranty has the same meaning referred to in the ACL;
 - 'ACL' means Schedule 2 to the Competition and Consumer Act 2010;
 - 'Appliance' means any AEG product purchased by you and accompanied by this document;
 - 'ASC' means AEG authorised service centres;
 - AEG is the brand controlled by Electrolux Home Products Pty Ltd of 163 O'Riordan Street, Mascot NSW 2020, ABN 51 004 762 341 in respect of Appliances purchased in Australia and Electrolux (NZ) Limited (collectively 'Electrolux') of 3-5 Niall Burgess Road, Mount Wellington, in respect of Appliances purchased in New Zealand;
 - 'major failure' as referred to in clause 10 of this warranty has the same meaning referred to in the ACL and includes a situation when an Appliance cannot be repaired or it is uneconomic for Electrolux, at its discretion, to repair an Appliance during the Warranty Period;
 - 'Warranty Period' means the Appliance is warranted against manufacturing defects in Australia and New Zealand for 60 months, following the date of original purchase of the Appliance;
 - 'you' means the purchaser of the Appliance not having purchased the Appliance for re-sale, and 'your' has a corresponding meaning.
- This warranty only applies to Appliances purchased and used in Australia or New Zealand in normal domestic applications and is in addition to (and does not exclude, restrict, or modify in any way) any non-excludable statutory warranties in Australia or New Zealand.
 - During the Warranty Period Electrolux or its ASC will, at no extra charge if your Appliance is readily accessible for service, without special

equipment and subject to these terms and conditions, repair or replace any parts which it considers to be defective. Electrolux or its ASC may use remanufactured parts to repair your Appliance. You agree that any replaced Appliances or parts become the property of Electrolux. This warranty does not apply to light globes, batteries, filters or similar perishable parts.

4. Parts and Appliances not supplied by Electrolux are not covered by this warranty.
5. To the extent permitted by law, you will bear the cost of transportation, travel and delivery of the Appliance to and from Electrolux or its ASC. If you reside outside of the service area, you will bear the cost of:
 - a) travel of an authorised representative;
 - b) transportation and delivery of the Appliance to and from Electrolux or its ASC.

In all instances, unless the Appliance is transported by Electrolux or an AEG authorised representative, the Appliance is transported at the owner's cost and risk while in transit to and from Electrolux or its ASC.

6. Proof of purchase is required before you can make a claim under this warranty.
7. You may not make a claim under this warranty unless the defect claimed is due to faulty or defective parts or workmanship. Electrolux is not liable in the following situations (which are not exhaustive):
 - a) the Appliance is damaged by:
 - accident
 - misuse or abuse, including failure to properly maintain or service
 - normal wear and tear
 - power surges, electrical storm damage or incorrect power supply
 - incomplete or improper installation
 - incorrect, improper or inappropriate operation
 - insect or vermin infestation

- failure to comply with any additional instructions supplied with the Appliance;
- b) the Appliance is modified without authority from Electrolux in writing;
 - c) the Appliance's serial number or warranty seal has been removed or defaced;
 - d) the Appliance was serviced or repaired by anyone other than Electrolux, an authorised repairer or ASC.
8. This warranty, the contract to which it relates and the relationship between you and Electrolux are governed by the law applicable where the Appliance was purchased. Where the Appliance was purchased in New Zealand for commercial purposes the Consumer Guarantee Act does not apply.
 9. To the extent permitted by law and subject to your non-excludable statutory rights and warranties, AEG excludes all warranties and liabilities (other than as contained in this document) including liability for any loss or damage whether direct or indirect arising from your purchase, use or non use of the Appliance.
 10. For AEG Appliances and services in Australia, the Appliances come with a guarantee that cannot be excluded under the ACL. You are entitled to a replacement or refund for a major failure and for compensation for any other reasonably foreseeable loss or damage. You are also entitled to have the Appliance repaired or replaced if the Appliance fails to be of acceptable quality and the failure does not amount to a major failure. The benefits to you given by this warranty are in addition to your other rights and remedies under a law in relation to the Appliances or services to which the warranty relates.
 11. At all times during the Warranty Period, Electrolux shall, at its discretion, determine whether repair, replacement or refund will apply if an Appliance has a valid warranty claim applicable to it.
 12. For Appliances and services provided in New Zealand, the Appliances

- come with a guarantee pursuant to the provisions of the Consumer Guarantees Act, the Sale of Goods Act and the Fair Trading Act.
13. To enquire about claiming under this warranty, please follow these steps:
 - a) carefully check the operating instructions, user manual and the terms of this warranty;
 - b) have the model and serial number of the Appliance available;
 - c) have the proof of purchase (e.g. an invoice) available;
 - d) telephone the numbers shown below.
14. You accept that if you make a warranty claim, Electrolux and its ASC may exchange information in relation to you to enable Electrolux to meet its obligations under this warranty.

Important Notice

Before calling for service, please ensure that the steps listed in clause 13 above have been followed.

SERVICE AUSTRALIA



FOR SERVICE

or to find the address of your nearest state service centre in Australia

PLEASE CALL 1300 363 664

OR EMAIL customercare@aegaustralia.com.au

For the cost of a local call (Australia only)

FOR SPARE PARTS

or to find the address of your nearest state spare parts centre in Australia

PLEASE CALL 13 13 50

OR EMAIL customercare@aegaustralia.com.au

For the cost of a local call (Australia only)

SERVICE NEW ZEALAND



FOR SERVICE

or to find the address of your nearest authorised service centre in New Zealand

FREE CALL 0800 10 66 10

OR EMAIL customercare@electrolux.co.nz

(New Zealand only)

FOR SPARE PARTS

or to find the address of your nearest state spare parts centre in New Zealand

FREE CALL 0800 10 66 20

OR EMAIL customercare@electrolux.co.nz

(New Zealand only)

13. ENVIRONMENT CONCERNS

Recycle the materials with the symbol . Put the packaging in applicable containers to recycle it. Help protect the environment and human health and to recycle waste of electrical and electronic appliances. Do not dispose appliances

marked with the symbol  with the household waste. Return the product to your local recycling facility or contact your municipal office.

www.aeg.com/au

867312392-A-412014



 **AEG**
perfekt in form und funktion